

- ★ 100% EAS Guaranteed
- ★ Green Device Available
- ★ Super Low Gate Charge
- ★ Excellent CdV/dt effect decline
- ★ Advanced high cell density Trench technology

**Product Summary**

BVDSS	RDSON	ID
30V	12mΩ	9A

**Description**

The FKS3014 is the high cell density trenched N-ch MOSFETs, which provide excellent RDSON and gate charge for most of the synchronous buck converter applications.

The FKS3014 meet the RoHS and Green Product requirement 100% EAS guaranteed with full function reliability approved.

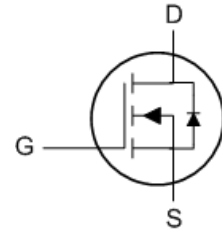
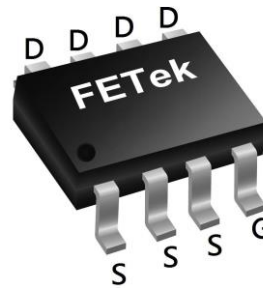
**S0P8 Pin Configuration**

**Absolute Maximum Ratings**

Symbol	Parameter	Rating	Units
$V_{DS}$	Drain-Source Voltage	30	V
$V_{GS}$	Gate-Source Voltage	$\pm 20$	V
$I_D @ T_A = 25^\circ C$	Continuous Drain Current, $V_{GS} @ 10V^1$	9	A
$I_D @ T_A = 70^\circ C$	Continuous Drain Current, $V_{GS} @ 10V^1$	7	A
$I_{DM}$	Pulsed Drain Current <sup>2</sup>	36	A
EAS	Single Pulse Avalanche Energy <sup>3</sup>	24.2	mJ
$I_{AS}$	Avalanche Current	22	A
$P_D @ T_A = 25^\circ C$	Total Power Dissipation <sup>4</sup>	1.5	W
$T_{STG}$	Storage Temperature Range	-55 to 150	$^\circ C$
$T_J$	Operating Junction Temperature Range	-55 to 150	$^\circ C$

**Thermal Data**

Symbol	Parameter	Typ.	Max.	Unit
$R_{\theta JA}$	Thermal Resistance Junction-Ambient <sup>1</sup>	---	85	$^\circ C/W$
$R_{\theta JC}$	Thermal Resistance Junction-Case <sup>1</sup>	---	25	$^\circ C/W$

**Electrical Characteristics (T<sub>J</sub>=25 °C, unless otherwise noted)**

Symbol	Parameter	Conditions	Min.	Typ.	Max.	Unit
BV <sub>DSS</sub>	Drain-Source Breakdown Voltage	V <sub>GS</sub> =0V, I <sub>D</sub> =250uA	30	---	---	V
ΔBV <sub>DSS</sub> /ΔT <sub>J</sub>	BVDSS Temperature Coefficient	Reference to 25°C, I <sub>D</sub> =1mA	---	0.023	---	V/°C
R <sub>DS(on)</sub>	Static Drain-Source On-Resistance <sup>2</sup>	V <sub>GS</sub> =10V, I <sub>D</sub> =8A	---	10	12	mΩ
		V <sub>GS</sub> =4.5V, I <sub>D</sub> =6A	---	15	18	
V <sub>GS(th)</sub>	Gate Threshold Voltage	V <sub>GS</sub> =V <sub>DS</sub> , I <sub>D</sub> =250uA	1.2	1.5	2.5	V
ΔV <sub>GS(th)</sub>	V <sub>GS(th)</sub> Temperature Coefficient		---	-5.08	---	mV/°C
I <sub>DSS</sub>	Drain-Source Leakage Current	V <sub>DS</sub> =24V, V <sub>GS</sub> =0V, T <sub>J</sub> =25°C	---	---	1	uA
		V <sub>DS</sub> =24V, V <sub>GS</sub> =0V, T <sub>J</sub> =55°C	---	---	5	
I <sub>GSS</sub>	Gate-Source Leakage Current	V <sub>GS</sub> =±20V, V <sub>DS</sub> =0V	---	---	±100	nA
g <sub>fs</sub>	Forward Transconductance	V <sub>DS</sub> =5V, I <sub>D</sub> =8A	---	24	---	S
R <sub>g</sub>	Gate Resistance	V <sub>DS</sub> =0V, V <sub>GS</sub> =0V, f=1MHz	---	1.8	3	Ω
Q <sub>g</sub>	Total Gate Charge (4.5V)	V <sub>DS</sub> =15V, V <sub>GS</sub> =4.5V, I <sub>D</sub> =8A	---	9.63	13.5	nC
Q <sub>gs</sub>	Gate-Source Charge		---	3.88	5.4	
Q <sub>gd</sub>	Gate-Drain Charge		---	3.44	4.8	
T <sub>d(on)</sub>	Turn-On Delay Time	V <sub>DD</sub> =15V, V <sub>GS</sub> =10V, R <sub>G</sub> =1.5Ω I <sub>D</sub> =8A	---	4.2	8.4	ns
T <sub>r</sub>	Rise Time		---	8.2	15	
T <sub>d(off)</sub>	Turn-Off Delay Time		---	31	62	
T <sub>f</sub>	Fall Time		---	4	8	
C <sub>iss</sub>	Input Capacitance	V <sub>DS</sub> =15V, V <sub>GS</sub> =0V, f=1MHz	---	940	1316	pF
C <sub>oss</sub>	Output Capacitance		---	131	183	
C <sub>rss</sub>	Reverse Transfer Capacitance		---	109	153	

**Diode Characteristics**

Symbol	Parameter	Conditions	Min.	Typ.	Max.	Unit
I <sub>S</sub>	Continuous Source Current <sup>1,5</sup>	V <sub>G</sub> =V <sub>D</sub> =0V, Force Current	---	---	9	A
I <sub>SM</sub>	Pulsed Source Current <sup>2,5</sup>		---	---	36	A
V <sub>SD</sub>	Diode Forward Voltage <sup>2</sup>	V <sub>GS</sub> =0V, I <sub>S</sub> =1A, T <sub>J</sub> =25°C	---	---	1	V
t <sub>rr</sub>	Reverse Recovery Time	I <sub>F</sub> =8A, di/dt=100A/μs, T <sub>J</sub> =25°C	---	8	---	nS
Q <sub>rr</sub>	Reverse Recovery Charge		---	2.9	---	nC

Note :

- 1.The data tested by surface mounted on a 1 inch<sup>2</sup> FR-4 board with 2OZ copper.
- 2.The data tested by pulsed, pulse width ≤ 300us, duty cycle ≤ 2%
- 3.The EAS data shows Max. rating. The test condition is V<sub>DD</sub>=25V, V<sub>GS</sub>=10V, L=0.1mH, I<sub>AS</sub>=22A
- 4.The power dissipation is limited by 150°C junction temperature
- 5.The data is theoretically the same as I<sub>D</sub> and I<sub>DM</sub>, in real applications, should be limited by total power dissipation.

**Typical Characteristics**

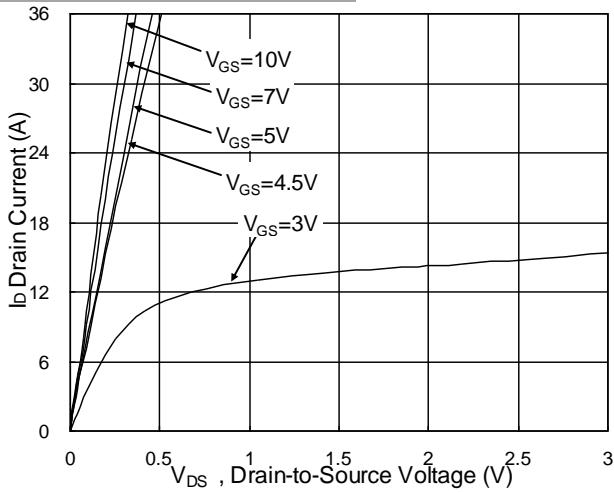

**Fig.1 Typical Output Characteristics**

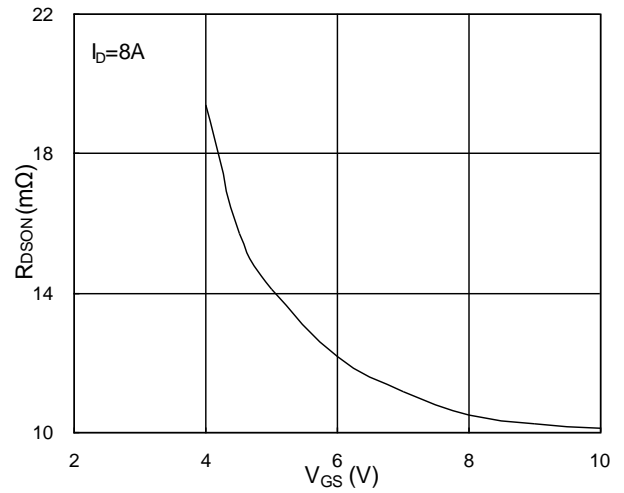

**Fig.2 On-Resistance vs. G-S Voltage**

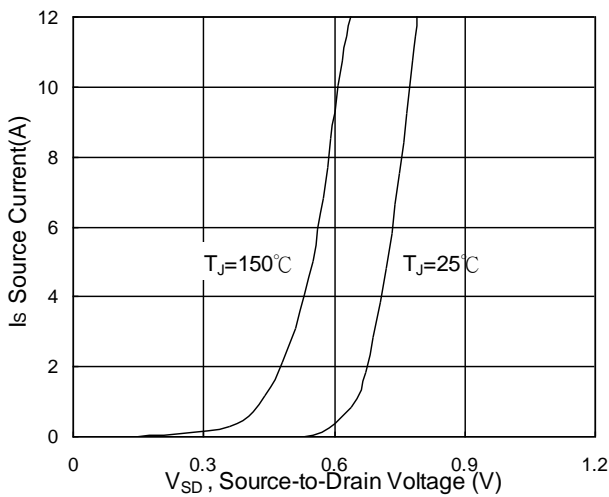

**Fig.3 Forward Characteristics of Reverse**

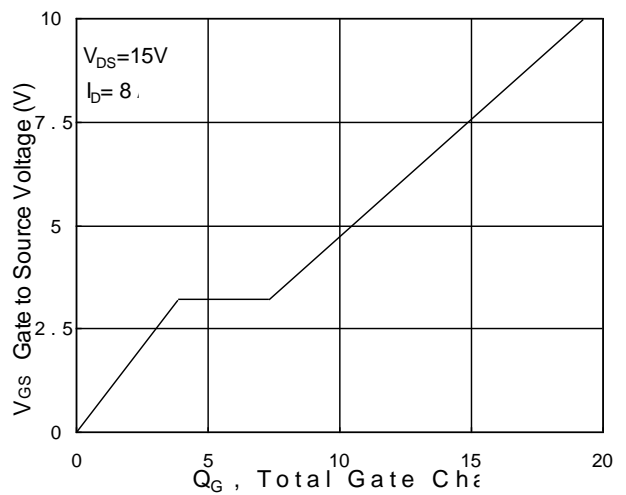

**Fig.4 Gate-Charge Characteristics**

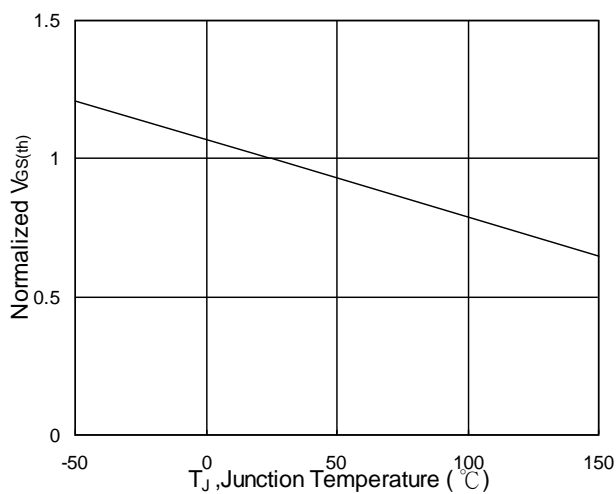

**Fig.5 Normalized  $V_{GS(th)}$  vs.  $T_J$**

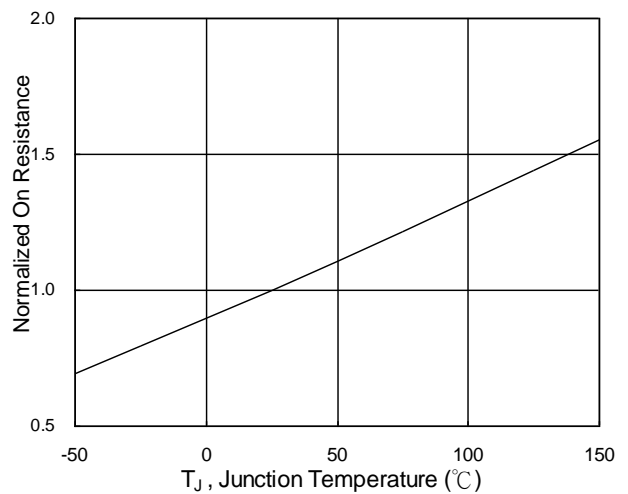

**Fig.6 Normalized  $R_{DS(on)}$  vs.  $T_J$**

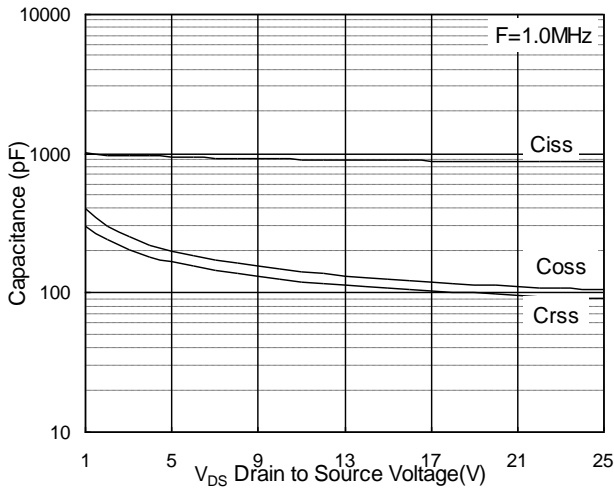

**Fig.7 Capacitance**

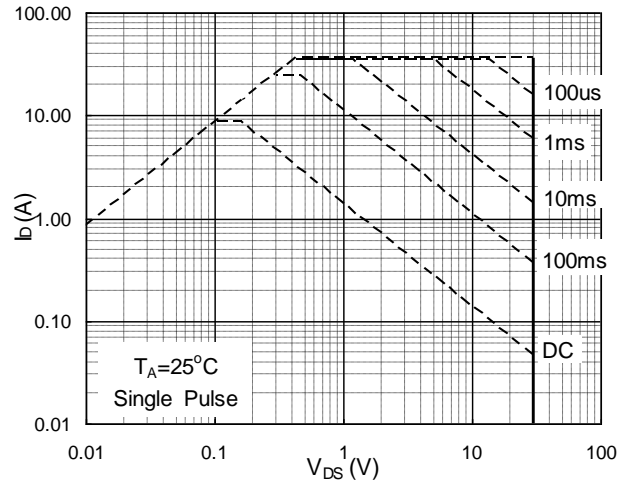

**Fig.8 Safe Operating Area**

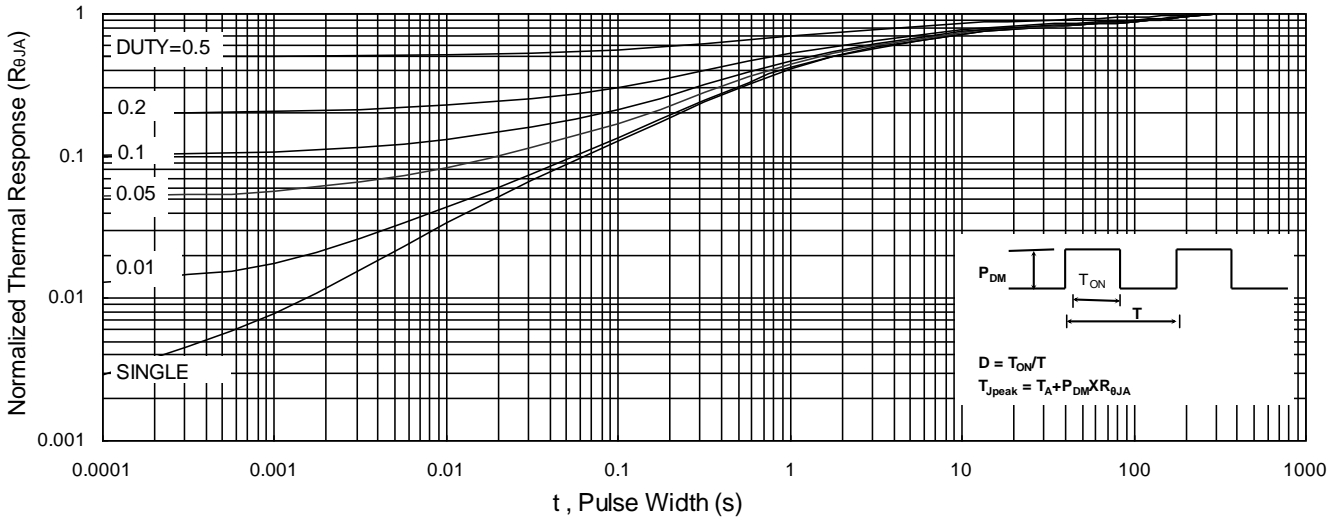

**Fig.9 Normalized Maximum Transient Thermal Impedance**

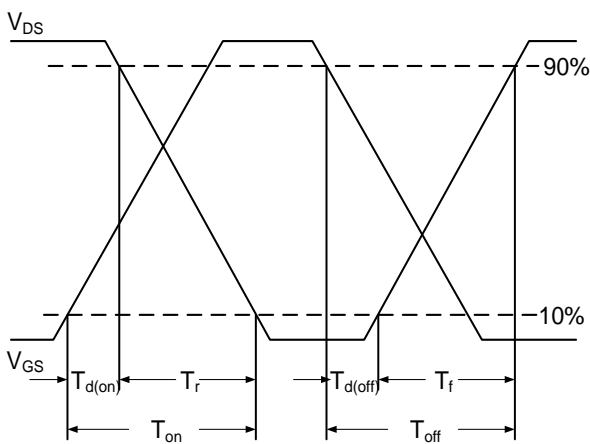

**Fig.10 Switching Time Waveform**

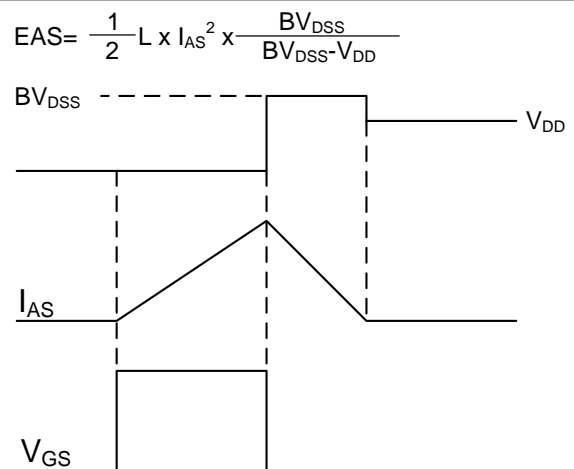

**Fig.11 Unclamped Inductive Switching Waveform**