



- ★ Green Device Available
- ★ Super Low Gate Charge
- ★ ESD Protection
- ★ Excellent Cdv/dt effect decline
- ★ Advanced high cell density Trench

Product Summary

BVDSS	RDSON	ID
20V	17mΩ	7A

Description

The FKQ2724 is the high cell density trenched N-ch MOSFETs, which provides excellent RDSON and efficiency for most of the small power switching and load switch applications.

The FKQ2724 meet the RoHS and Green Product requirement with full function reliability approved.

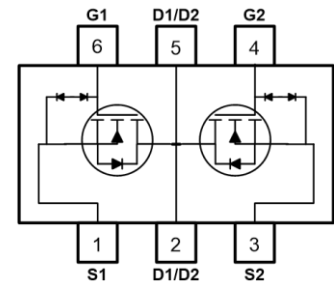
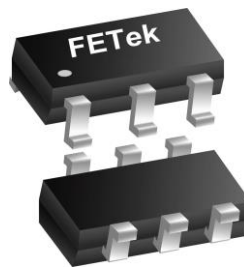
TSOP6 Pin Configuration**Absolute Maximum Ratings**

Symbol	Parameter	Rating	Units
V_{DS}	Drain-Source Voltage	20	V
V_{GS}	Gate-Source Voltage	± 12	V
$I_D@T_A=25^\circ\text{C}$	Continuous Drain Current ¹	7.0	A
$I_D@T_A=70^\circ\text{C}$	Continuous Drain Current ¹	5.6	A
I_{DM}	Pulsed Drain Current ²	45	A
$P_D@T_A=25^\circ\text{C}$	Total Power Dissipation ³	1.25	W
T_{STG}	Storage Temperature Range	-55 to 150	$^\circ\text{C}$
T_J	Operating Junction Temperature Range	-55 to 150	$^\circ\text{C}$

Thermal Data

Symbol	Parameter	Typ.	Max.	Unit
$R_{\theta JA}$	Thermal Resistance Junction-ambient ¹	---	100	$^\circ\text{C/W}$

**N-Channel Electrical Characteristics (T_J=25 °C, unless otherwise noted)**

Symbol	Parameter	Conditions	Min.	Typ.	Max.	Unit
BV _{DSS}	Drain-Source Breakdown Voltage	V _{GS} =0V, I _D =250uA	20	---	---	V
R _{DS(ON)}	Static Drain-Source On-Resistance ²	V _{GS} =4.5V, I _D =3.5A	12	14	17	mΩ
		V _{GS} =4.0V, I _D =3.5A	12.5	14.5	17.5	
		V _{GS} =3.7V, I _D =3.5A	13	15	18	
		V _{GS} =3.1V, I _D =3.5A	14	16	20	
		V _{GS} =2.5V, I _D =3.5A	16	19.5	24.5	
V _{GS(th)}	Gate Threshold Voltage	V _{GS} =V _{DS} , I _D =250uA	0.5	0.7	1.2	V
I _{DSS}	Drain-Source Leakage Current	V _{DS} =16V, V _{GS} =0V, T _J =25°C	---	---	1	uA
		V _{DS} =16V, V _{GS} =0V, T _J =55°C	---	---	5	
I _{GSS}	Gate-Source Leakage Current	V _{GS} =±8V, V _{DS} =0V	---	---	±10	uA
g _{fs}	Forward Transconductance	V _{DS} =5V, I _D =3.5A	---	20	---	S
Q _g	Total Gate Charge	V _{DS} =15V, V _{GS} =4.5V, I _D =7A	---	11	---	nC
Q _{gs}	Gate-Source Charge		---	1.2	---	
Q _{gd}	Gate-Drain Charge		---	3.2	---	
T _{d(on)}	Turn-On Delay Time	V _{DD} =15V, V _{GS} =4.5V, R _G =3.3Ω I _D =3.5A	---	52	---	ns
T _r	Rise Time		---	302	---	
T _{d(off)}	Turn-Off Delay Time		---	805	---	
T _f	Fall Time		---	662	---	
C _{iss}	Input Capacitance	V _{DS} =15V, V _{GS} =0V, f=1MHz	---	523	---	pF
C _{oss}	Output Capacitance		---	81	---	
C _{rss}	Reverse Transfer Capacitance		---	56	---	

Diode Characteristics

Symbol	Parameter	Conditions	Min.	Typ.	Max.	Unit
I _S	Continuous Source Current ^{1,4}	V _G =V _D =0V, Force Current	---	---	7	A
V _{SD}	Diode Forward Voltage ²	V _{GS} =0V, I _S =1A, T _J =25°C	---	0.78	1.2	V

Note :

1. The data tested by surface mounted on a 1 inch² FR-4 board with 2OZ copper, t ≤ 10s.
2. The data tested by pulsed, pulse width ≤ 300us, duty cycle ≤ 2%
3. The power dissipation is limited by 150°C junction temperature
4. The data is theoretically the same as I_D and I_{DM}, in real applications, should be limited by total power dissipation.

N-Channel Typical Characteristics

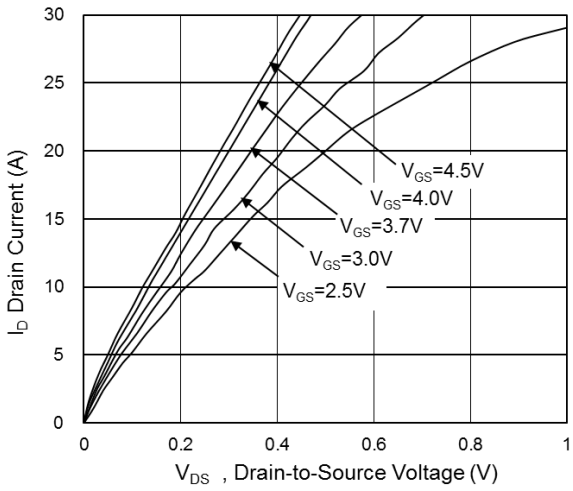

Fig.1 Typical Output Characteristics

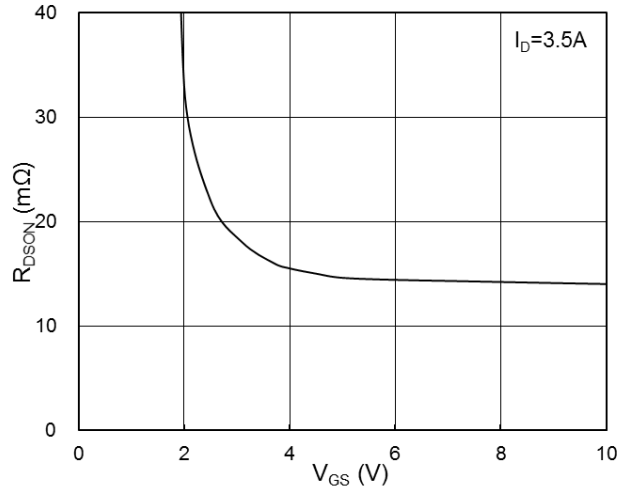

Fig.2 On-Resistance vs. G-S voltage

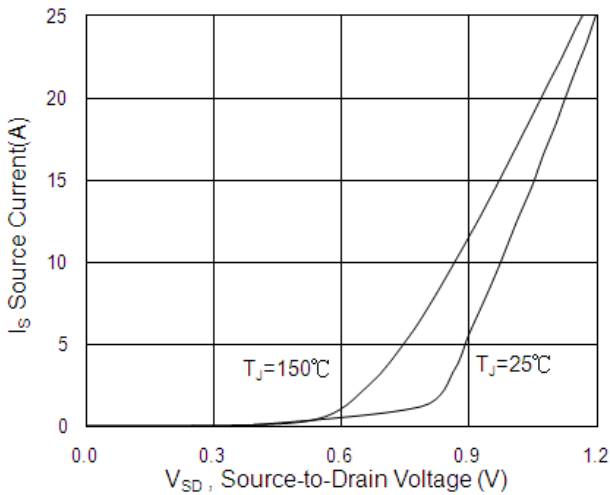

Fig.3 Source-Drain Forward Characteristics

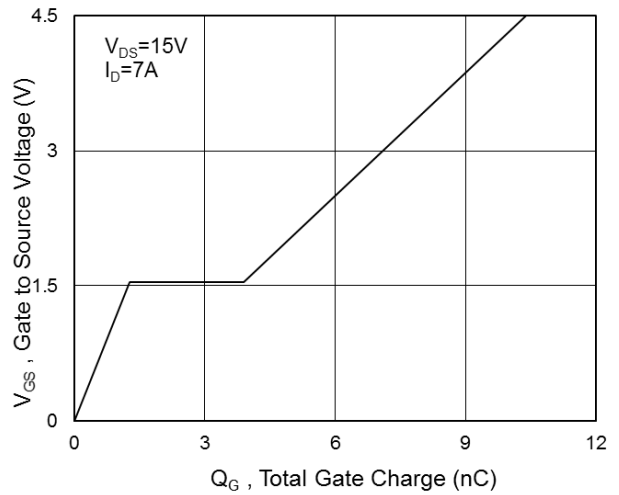

Fig.4 Gate-Charge Characteristics

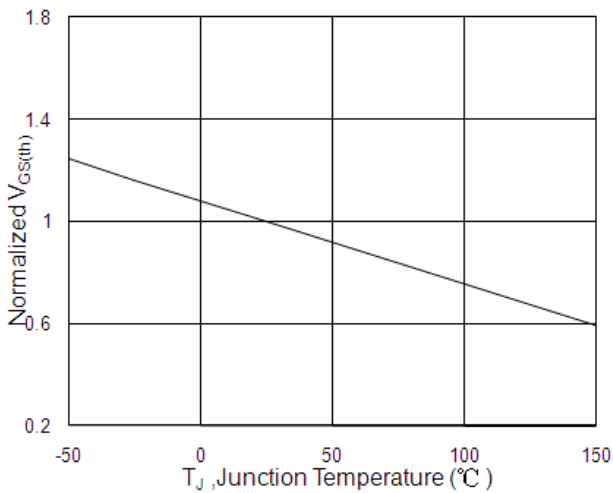

Fig.5 Normalized $V_{GS(th)}$ vs. T_J

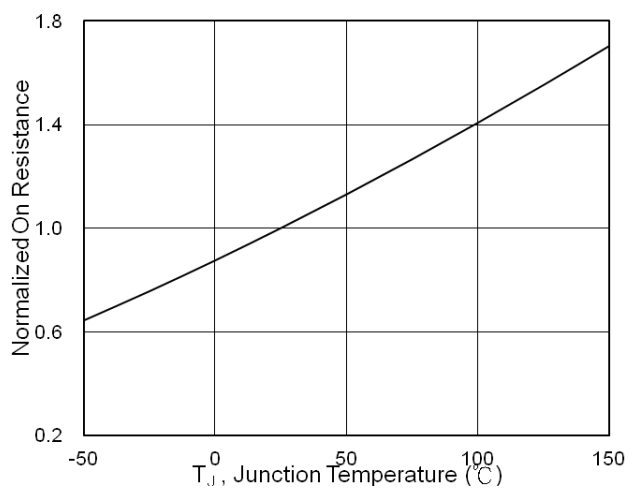

Fig.6 Normalized $R_{DS(on)}$ vs. T_J

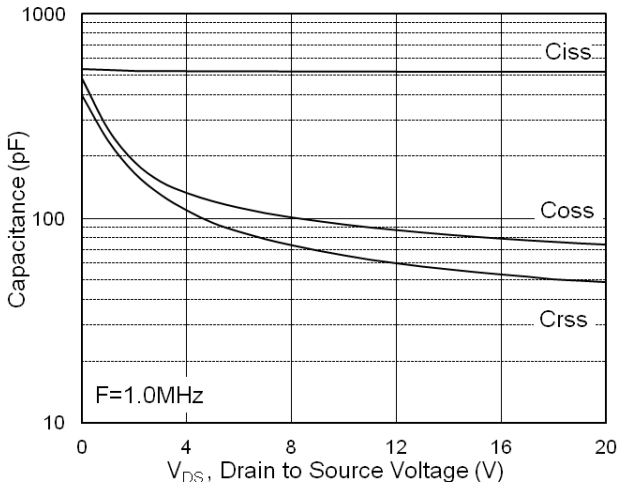

Fig.7 Capacitance

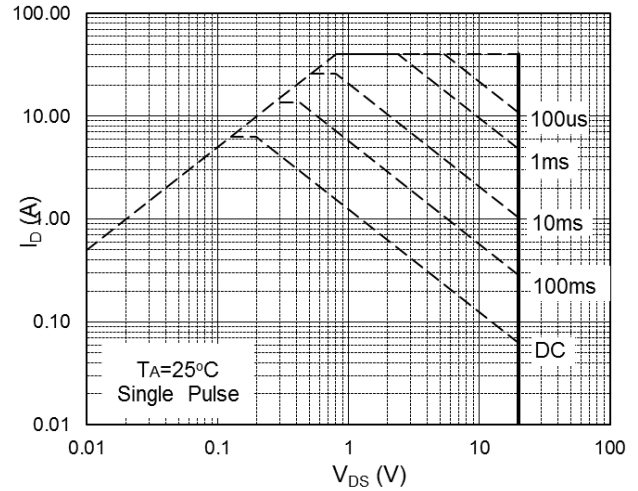

Fig.8 Safe Operating Area

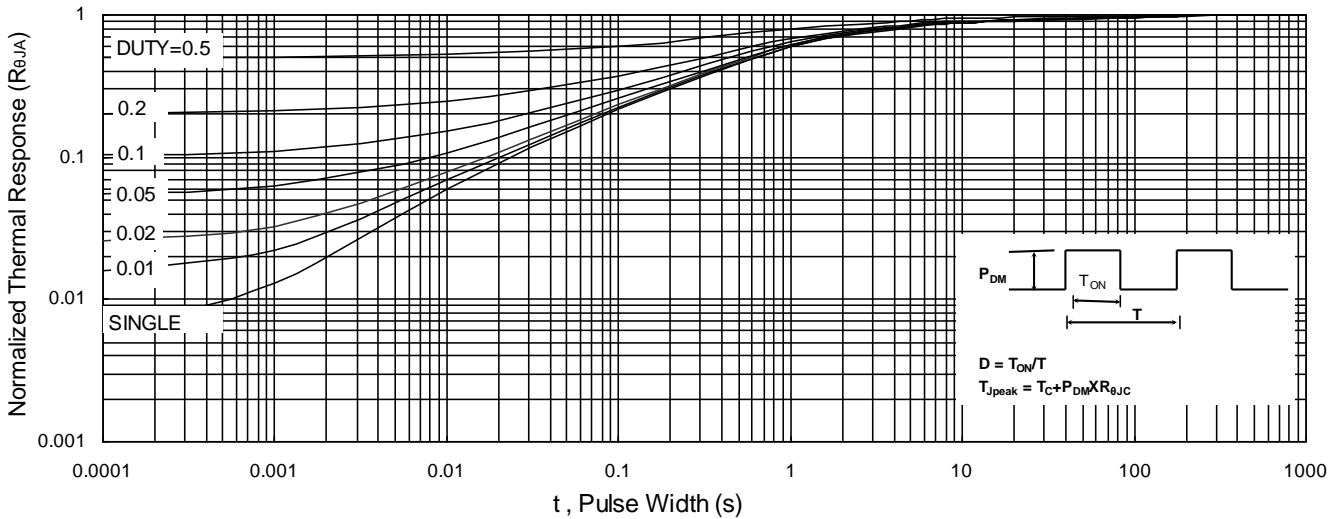

Fig.9 Normalized Maximum Transient Thermal Impedance

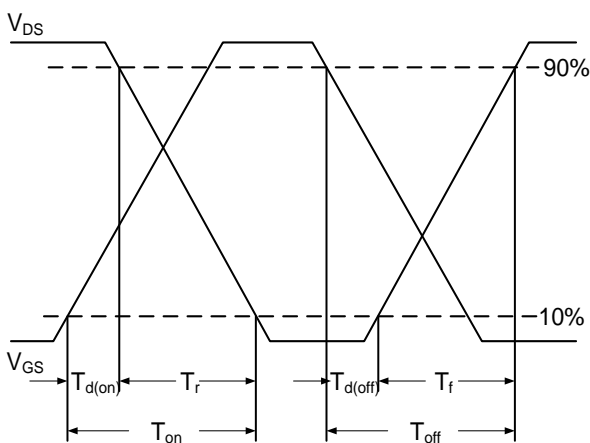

Fig.10 Switching Time Waveform

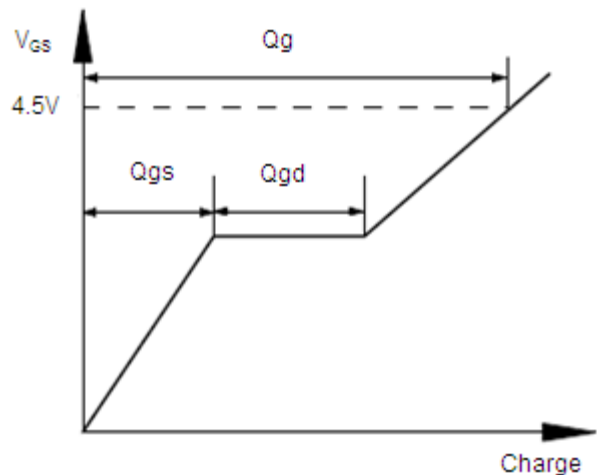
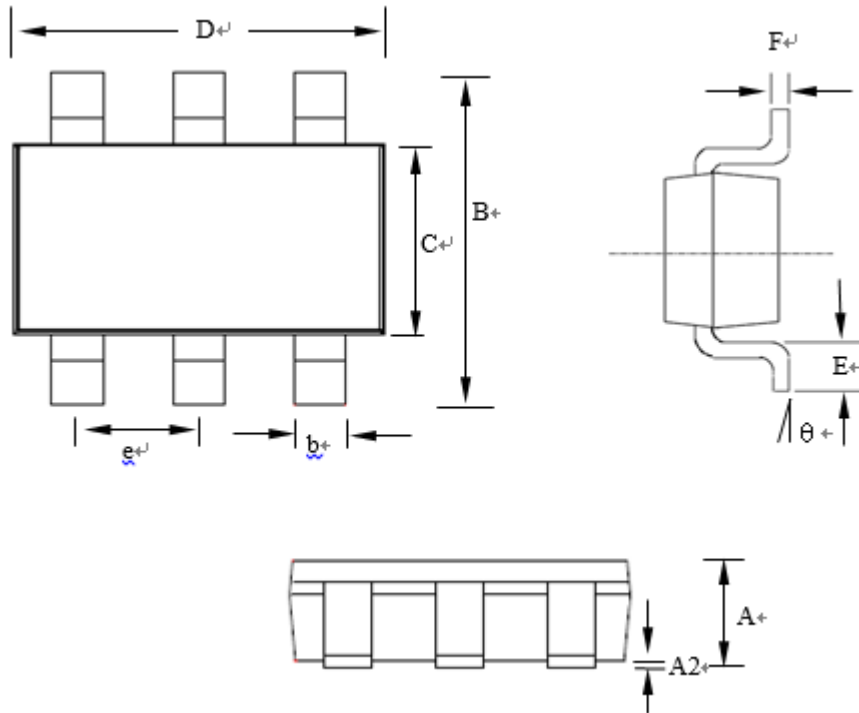

Fig.11 Gate Charge Waveform

TSOP6 Package Outline Dimensions



SYMBOLS	MILLIMETERS			INCHES		
	MIN	NOM	MAX	MIN	NOM	MAX
A	0.70	--	0.9	0.028	--	0.035
A2	0.00	--	0.10	0.000	--	0.004
B	2.60	2.80	3.00	0.102	0.110	0.118
C	1.40	1.60	1.80	0.055	0.063	0.071
D	2.70	2.90	3.10	0.106	0.114	0.122
E	0.30	0.40	0.60	0.012	0.016	0.024
F	0.07	0.127	0.20	0.003	0.005	0.008
b	0.30	0.40	0.50	0.012	0.016	0.020
e	--	0.95	--	--	0.037	--
θ	0°	5°	10°	0°	5°	10°

Marking Instruction

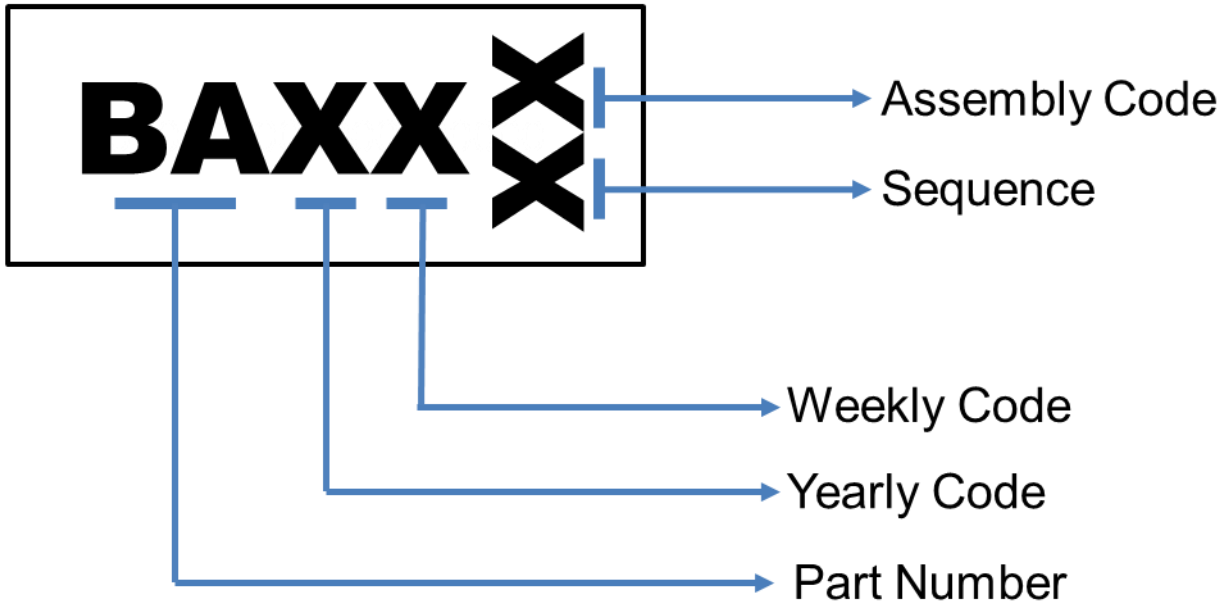

TSOP6 Tape and Reel Data

