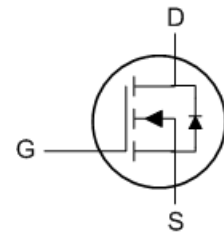
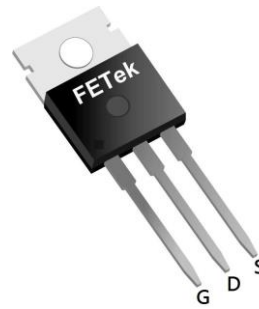

**General Description**

- Advanced Trench MOS Technology
- Low Gate Charge
- LOW  $R_{DS(ON)}$
- 100% EAS Guaranteed
- Green Device Available

**Product Summary**

BVDSS	RDSON	ID
150V	13mΩ	85A

**TO220 Pin Configuration**

**Applications**

- Load Switch
- LED Applications
- Networking Applications
- Quick Charger

**Absolute Maximum Ratings**

Symbol	Parameter	Rating	Units
$V_{DS}$	Drain-Source Voltage	150	V
$V_{GS}$	Gate-Source Voltage	$\pm 20$	V
$I_D@T_C=25^\circ C$	Continuous Drain Current, $V_{GS} @ 10V^1$	85	A
$I_D@T_C=100^\circ C$	Continuous Drain Current, $V_{GS} @ 10V^1$	54	A
$I_D@T_A=25^\circ C$	Continuous Drain Current, $V_{GS} @ 10V^1$	9.6	A
$I_D@T_A=70^\circ C$	Continuous Drain Current, $V_{GS} @ 10V^1$	7.7	A
$I_{DM}$	Pulsed Drain Current <sup>2</sup>	180	A
EAS	Single Pulse Avalanche Energy <sup>3</sup>	420	mJ
$I_{AS}$	Avalanche Current	41	A
$P_D@T_C=25^\circ C$	Total Power Dissipation <sup>4</sup>	178	W
$T_{STG}$	Storage Temperature Range	-55 to 150	$^\circ C$
$T_J$	Operating Junction Temperature Range	-55 to 150	$^\circ C$

**Thermal Data**

Symbol	Parameter	Typ.	Max.	Unit
$R_{\theta JA}$	Thermal Resistance Junction-Ambient <sup>1</sup>	---	55	$^\circ C/W$
$R_{\theta JC}$	Thermal Resistance Junction-Case <sup>1</sup>	---	0.7	$^\circ C/W$

**Electrical Characteristics (T<sub>J</sub>=25 °C, unless otherwise noted)**

Symbol	Parameter	Conditions	Min.	Typ.	Max.	Unit
BV <sub>DSS</sub>	Drain-Source Breakdown Voltage	V <sub>GS</sub> =0V, I <sub>D</sub> =250uA	150	---	---	V
R <sub>DS(ON)</sub>	Static Drain-Source On-Resistance <sup>2</sup>	V <sub>GS</sub> =10V, I <sub>D</sub> =20A	---	9.8	13	mΩ
		V <sub>GS</sub> =4.5V, I <sub>D</sub> =20A	---	11	15	
V <sub>GS(th)</sub>	Gate Threshold Voltage	V <sub>GS</sub> =V <sub>DS</sub> , I <sub>D</sub> =250uA	1.2	1.7	2.5	V
I <sub>DSS</sub>	Drain-Source Leakage Current	V <sub>DS</sub> =120V, V <sub>GS</sub> =0V, T <sub>J</sub> =25°C	---	---	1	uA
		V <sub>DS</sub> =120V, V <sub>GS</sub> =0V, T <sub>J</sub> =55°C	---	---	5	
I <sub>GSS</sub>	Gate-Source Leakage Current	V <sub>GS</sub> =±20V, V <sub>DS</sub> =0V	---	---	±100	nA
R <sub>g</sub>	Gate Resistance	V <sub>DS</sub> =0V, V <sub>GS</sub> =0V, f=1MHz	---	1.5	---	Ω
Q <sub>g</sub>	Total Gate Charge	V <sub>DS</sub> =75V, V <sub>GS</sub> =4.5V, I <sub>D</sub> =20A	---	37	---	nC
Q <sub>gs</sub>	Gate-Source Charge		---	12.3	---	
Q <sub>gd</sub>	Gate-Drain Charge		---	17.7	---	
T <sub>d(on)</sub>	Turn-On Delay Time	V <sub>DD</sub> =75V, V <sub>GS</sub> =10V, R <sub>G</sub> =6Ω, I <sub>D</sub> =1A	---	12	---	ns
T <sub>r</sub>	Rise Time		---	18	---	
T <sub>d(off)</sub>	Turn-Off Delay Time		---	88	---	
T <sub>f</sub>	Fall Time		---	142	---	
C <sub>iss</sub>	Input Capacitance	V <sub>DS</sub> =75V, V <sub>GS</sub> =0V, f=1MHz	---	4137	---	pF
C <sub>oss</sub>	Output Capacitance		---	290	---	
C <sub>rss</sub>	Reverse Transfer Capacitance		---	22	---	

**Diode Characteristics**

Symbol	Parameter	Conditions	Min.	Typ.	Max.	Unit
I <sub>S</sub>	Continuous Source Current <sup>1,5,6</sup>	V <sub>G</sub> =V <sub>D</sub> =0V, Force Current	---	---	85	A
V <sub>SD</sub>	Diode Forward Voltage <sup>2</sup>	V <sub>GS</sub> =0V, I <sub>S</sub> =1A, T <sub>J</sub> =25°C	---	---	1.2	V
t <sub>rr</sub>	Reverse Recovery Time	I <sub>F</sub> =20A, di/dt=100A/μs,	---	76	---	nS
Q <sub>rr</sub>	Reverse Recovery Charge	T <sub>J</sub> =25°C	---	252	---	nC

Note :

- 1.The data tested by surface mounted on a 1 inch<sup>2</sup>FR-4 board with 20Z copper.
- 2.The data tested by pulsed, pulse width ≤ 300us, duty cycle ≤ 2%
- 3.The EAS data shows Max. rating. The test condition is V<sub>DD</sub>=50V, V<sub>GS</sub>=10V, L=0.5mH, I<sub>AS</sub>=41A
- 4.The power dissipation is limited by 175°C junction temperature
- 5.The data is theoretically the same as I<sub>D</sub> and I<sub>DM</sub>, in real applications, should be limited by total power dissipation.

Typical Characteristics

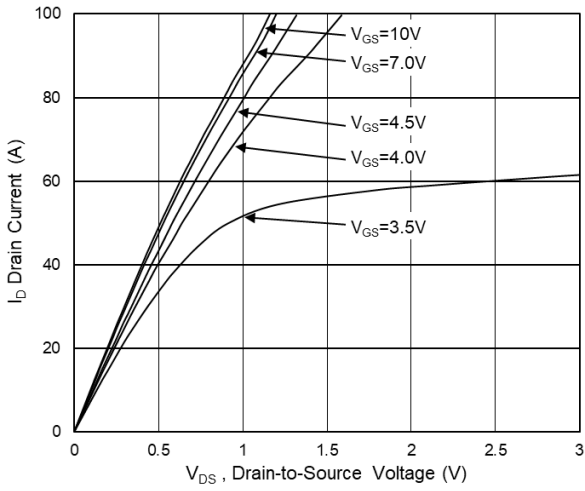

Fig.1 Typical Output Characteristics

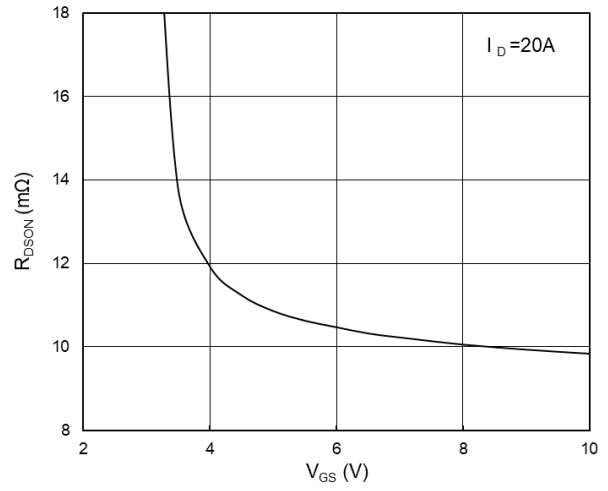

Fig.2 On-Resistance vs G-S Voltage

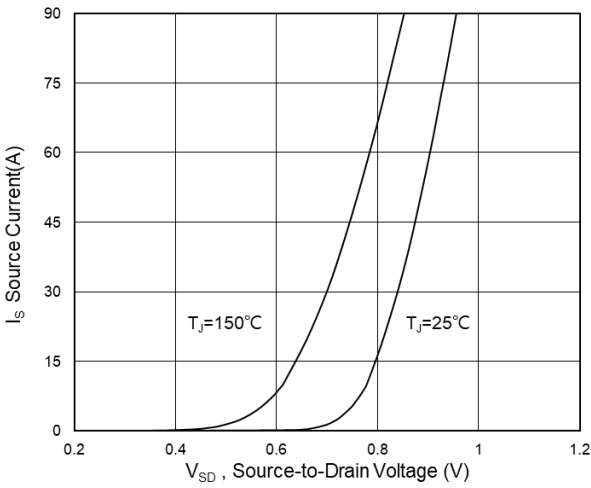

Fig.3 Source Drain Forward Characteristics

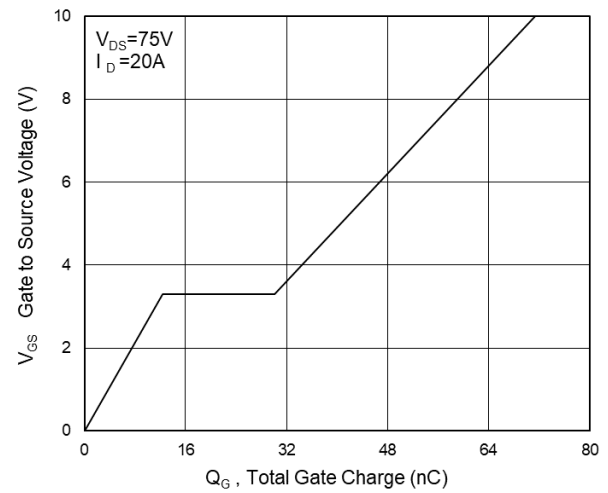

Fig.4 Gate-Charge Characteristics

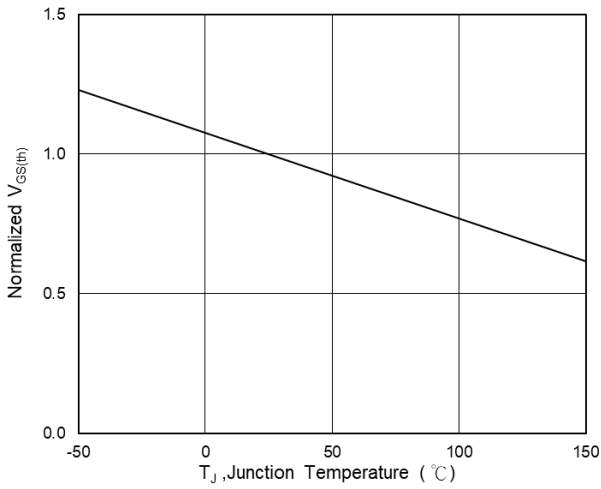

Fig.5 Normalized  $V_{GS(th)}$  vs  $T_J$

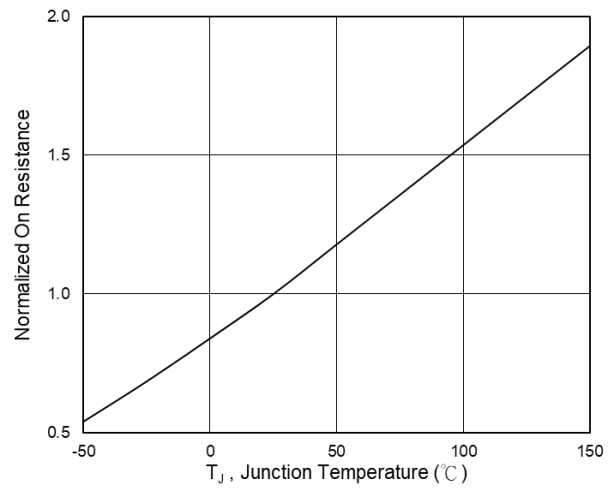

Fig.6 Normalized  $R_{DS(on)}$  vs  $T_J$

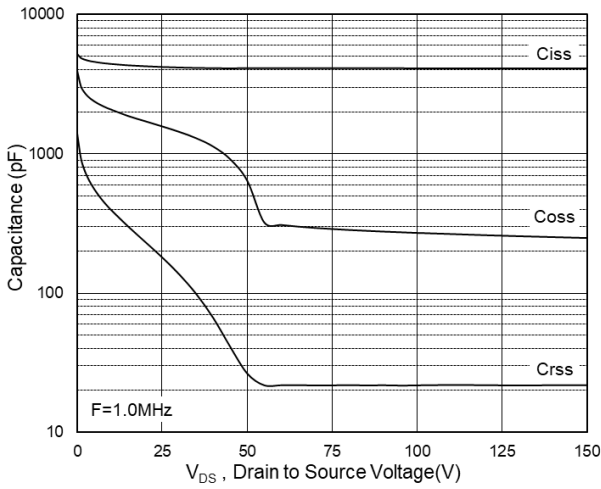

Fig.7 Capacitance

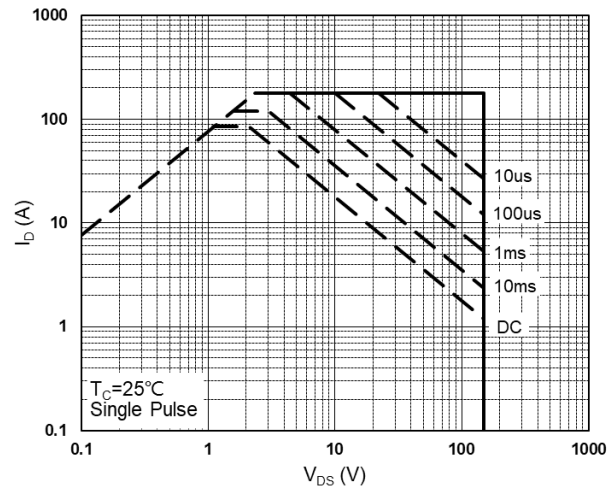

Fig.8 Safe Operating Area

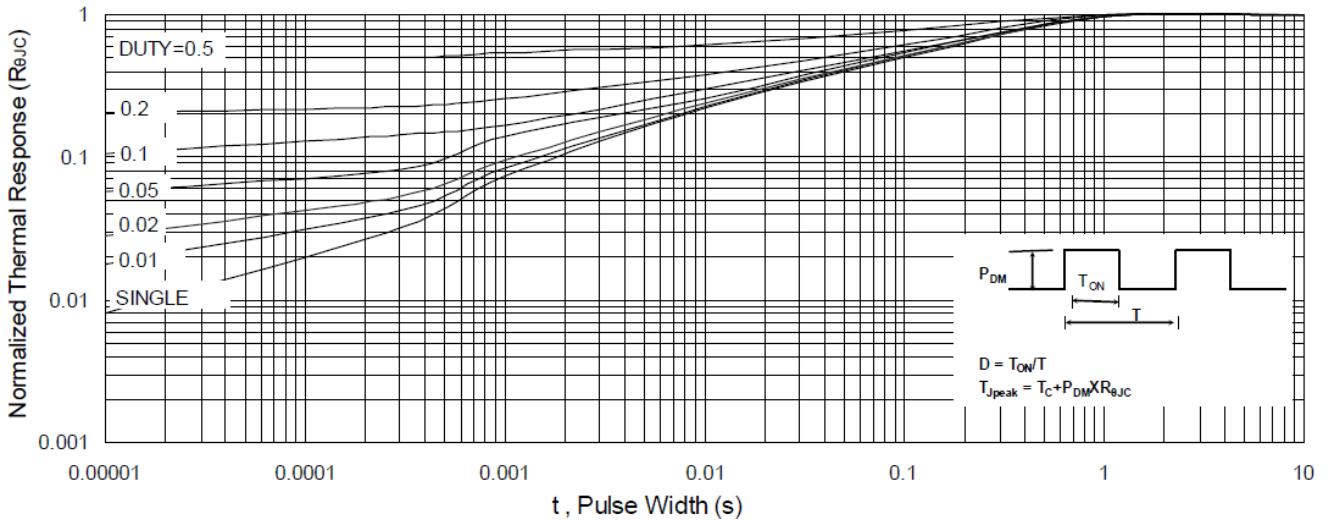

Fig.9 Normalized Maximum Transient Thermal Impedance

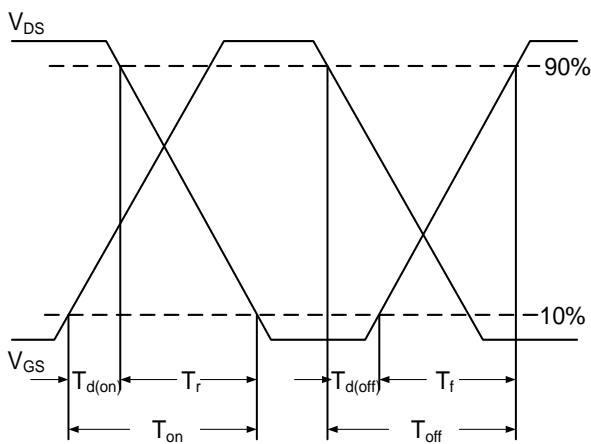

Fig.10 Switching Time Waveform

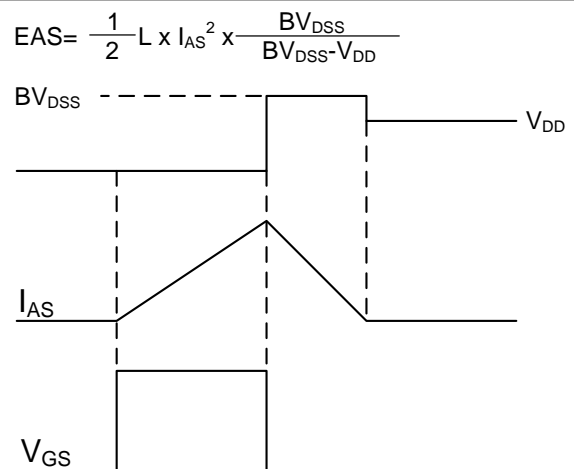

Fig.11 Unclamped Inductive Waveform