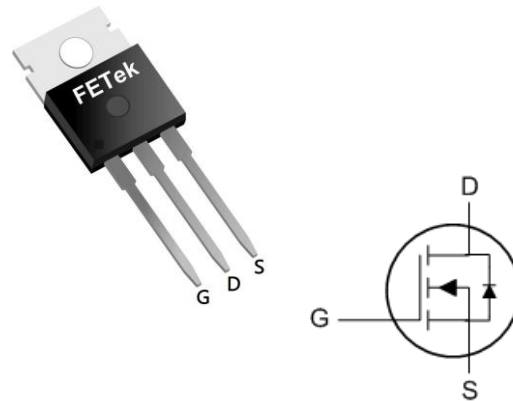

General Description

- Advanced Trench MOS Technology
- Low Gate Charge
- LOW $R_{DS(ON)}$
- 100% EAS Guaranteed
- Green Device Available

Product Summary

BVDSS	RDSON	ID
150V	9mΩ	100A

TO220 Pin Configuration

Applications

- Load Switch
- LED Applications
- Networking Applications
- Quick Charger

Absolute Maximum Ratings

Symbol	Parameter	Rating	Units
V_{DS}	Drain-Source Voltage	150	V
V_{GS}	Gate-Source Voltage	± 20	V
$I_D @ T_C = 25^\circ C$	Continuous Drain Current, $V_{GS} @ 10V^1$	100	A
$I_D @ T_C = 100^\circ C$	Continuous Drain Current, $V_{GS} @ 10V^1$	63	A
I_{DM}	Pulsed Drain Current ²	400	A
EAS	Single Pulse Avalanche Energy ³	784	mJ
I_{AS}	Avalanche Current	56	A
$P_D @ T_C = 25^\circ C$	Total Power Dissipation ⁴	178	W
T_{STG}	Storage Temperature Range	-55 to 150	$^\circ C$
T_J	Operating Junction Temperature Range	-55 to 150	$^\circ C$

Thermal Data

Symbol	Parameter	Typ.	Max.	Unit
$R_{\theta JA}$	Thermal Resistance Junction-Ambient ¹	---	50	$^\circ C/W$
$R_{\theta JC}$	Thermal Resistance Junction-Case ¹	---	0.7	$^\circ C/W$

**Electrical Characteristics ($T_J=25^\circ\text{C}$, unless otherwise noted)**

Symbol	Parameter	Conditions	Min.	Typ.	Max.	Unit
BV_{DSS}	Drain-Source Breakdown Voltage	$V_{GS}=0V, I_D=250\mu A$	150	---	---	V
$R_{DS(ON)}$	Static Drain-Source On-Resistance ²	$V_{GS}=10V, I_D=20A$	---	7.3	9	m Ω
$V_{GS(th)}$	Gate Threshold Voltage	$V_{GS}=V_{DS}, I_D=250\mu A$	2	3	4	V
I_{DSS}	Drain-Source Leakage Current	$V_{DS}=120V, V_{GS}=0V, T_J=25^\circ\text{C}$	---	---	1	μA
		$V_{DS}=120V, V_{GS}=0V, T_J=55^\circ\text{C}$	---	---	5	
I_{GSS}	Gate-Source Leakage Current	$V_{GS}=\pm 20V, V_{DS}=0V$	---	---	± 100	nA
R_g	Gate Resistance	$V_{DS}=0V, V_{GS}=0V, f=1\text{MHz}$	---	1.9	---	Ω
Q_g	Total Gate Charge	$V_{DS}=75V, V_{GS}=10V, I_D=20A$	---	100	---	nC
Q_{gs}	Gate-Source Charge		---	24.9	---	
Q_{gd}	Gate-Drain Charge		---	30.8	---	
$T_{d(on)}$	Turn-On Delay Time	$V_{DD}=30V, V_{GS}=10V, R_G=3.3\Omega, I_D=1A$	---	32	---	ns
T_r	Rise Time		---	25	---	
$T_{d(off)}$	Turn-Off Delay Time		---	97	---	
T_f	Fall Time		---	89	---	
C_{iss}	Input Capacitance	$V_{DS}=75V, V_{GS}=0V, f=1\text{MHz}$	---	5870	---	μF
C_{oss}	Output Capacitance		---	404	---	
C_{rss}	Reverse Transfer Capacitance		---	9.3	---	

Diode Characteristics

Symbol	Parameter	Conditions	Min.	Typ.	Max.	Unit
I_S	Continuous Source Current ¹	$V_G=V_D=0V$, Force Current	---	---	100	A
V_{SD}	Diode Forward Voltage ²	$V_{GS}=0V, I_S=1A, T_J=25^\circ\text{C}$	---	---	1.2	V

Note :

- 1.The data tested by surface mounted on a 1 inch² FR-4 board with 2OZ copper.
- 2.The data tested by pulsed , pulse width $\leq 300\mu s$, duty cycle $\leq 2\%$
- 3.The EAS data shows Max. rating . The test condition is $V_{DD}=50V, V_{GS}=10V, L=0.5mH, I_{AS}=56A$
- 4.The power dissipation is limited by 150°C junction temperature.
- 5.The data is theoretically the same as I_D and I_{DM} , in real applications , should be limited by total power dissipation.

Typical Characteristics

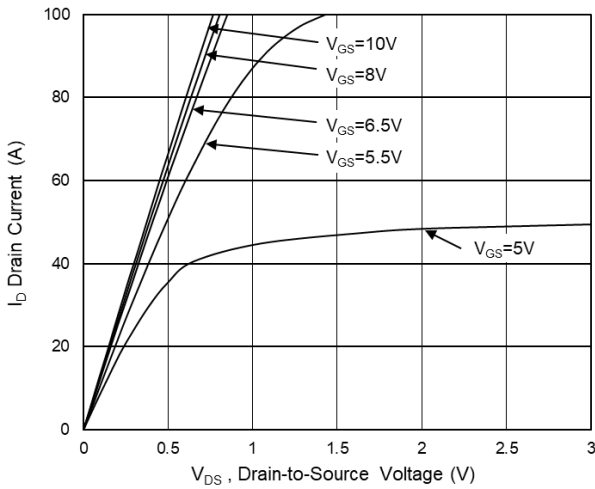

Fig.1 Typical Output Characteristics

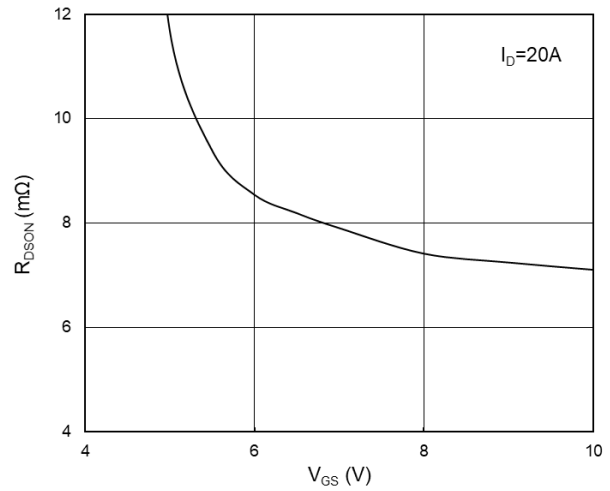

Fig.2 On-Resistance vs G-S Voltage

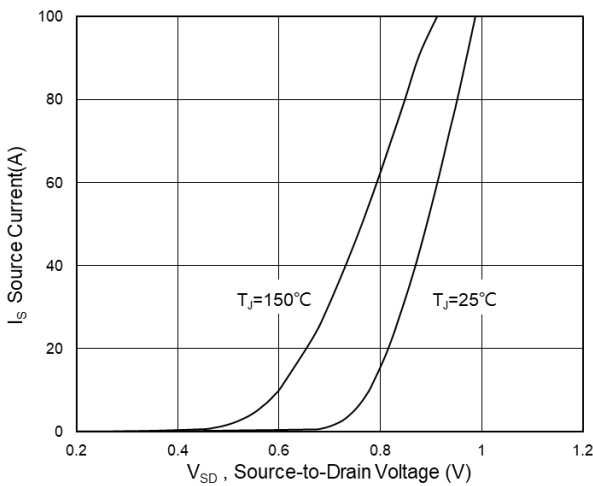

Fig.3 Source Drain Forward Characteristics

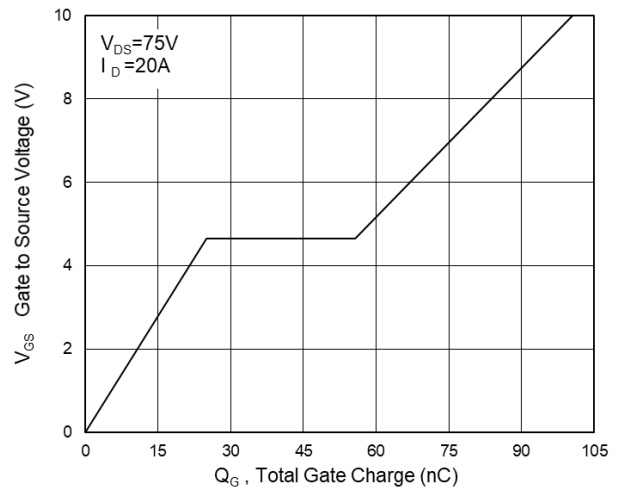

Fig.4 Gate-Charge Characteristics

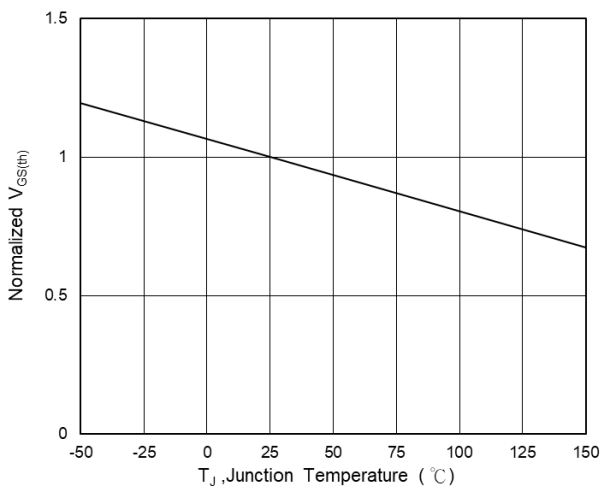

Fig.5 Normalized $V_{GS(th)}$ vs T_J

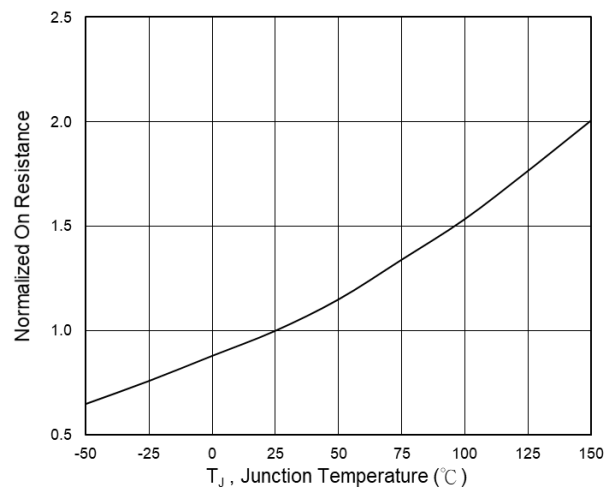

Fig.6 Normalized $R_{DS(on)}$ vs T_J

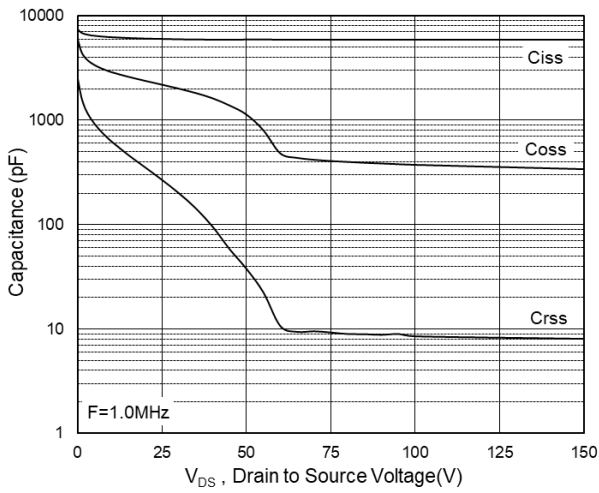

Fig.7 Capacitance

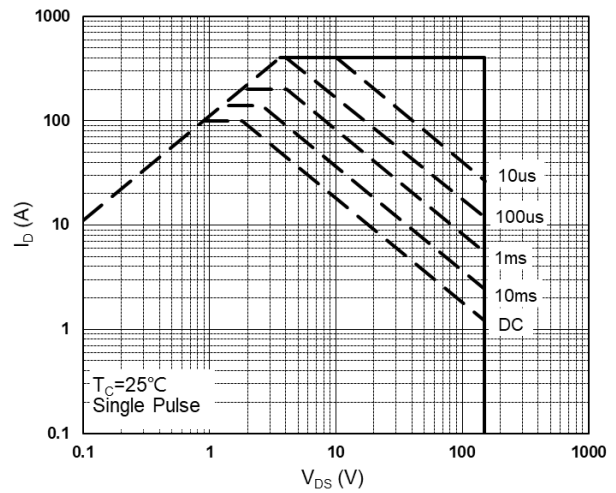

Fig.8 Safe Operating Area

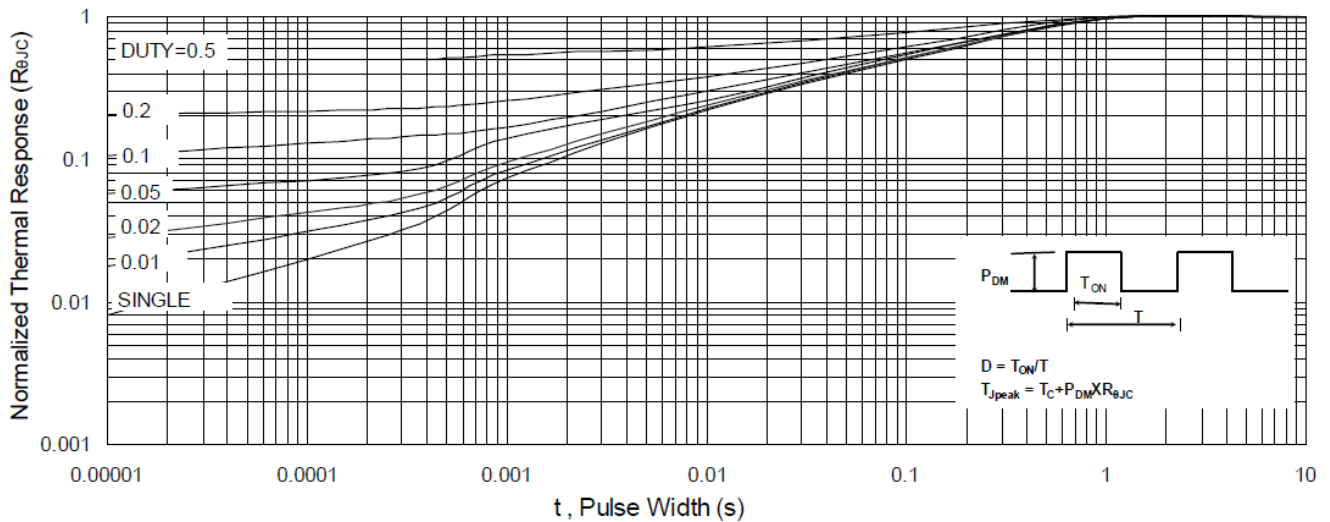

Fig.9 Normalized Maximum Transient Thermal Impedance



Fig.10 Switching Time Waveform



Fig.11 Unclamped Inductive Switching Waveform