



- ★ Green Device Available
- ★ Super Low Gate Charge
- ★ Excellent CdV/dt effect decline
- ★ Advanced high cell density Trench technology

Product Summary



BVDSS	RDSON	ID
60V	50mΩ	5A

Description

The FKL6014 is the high cell density trenched N-ch MOSFETs, which provide excellent RDSON and gate charge for most of the synchronous buck converter applications.

The FKL6014 meet the RoHS and Green Product requirement with full function reliability approved.

SOT223 Pin Configuration

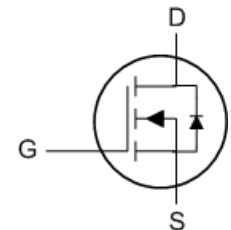
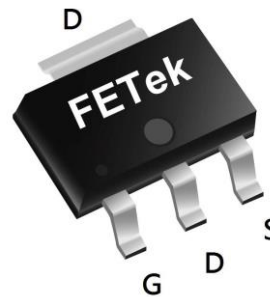

Absolute Maximum Ratings

Symbol	Parameter	Rating	Units
V_{DS}	Drain-Source Voltage	60	V
V_{GS}	Gate-Source Voltage	±20	V
$I_D@T_A=25^\circ\text{C}$	Continuous Drain Current, V_{GS} @ 10V ¹	5	A
$I_D@T_A=70^\circ\text{C}$	Continuous Drain Current, V_{GS} @ 10V ¹	3.5	A
I_{DM}	Pulsed Drain Current ²	30	A
EAS	Single Pulse Avalanche Energy ³	22	mJ
I_{AS}	Avalanche Current	21	A
$P_D@T_A=25^\circ\text{C}$	Total Power Dissipation ⁴	2.7	W
T_{STG}	Storage Temperature Range	-55 to 150	°C
T_J	Operating Junction Temperature Range	-55 to 150	°C

Thermal Data

Symbol	Parameter	Typ.	Max.	Unit
$R_{\theta JA}$	Thermal Resistance Junction-ambient ¹	---	85	°C/W
$R_{\theta JC}$	Thermal Resistance Junction-Case ¹	---	45	°C/W



Electrical Characteristics (T_J = 25 °C unless otherwise noted)

Symbol	Parameter	Conditions	Min.	Typ.	Max.	Unit
BV _{DSS}	Drain-Source Breakdown Voltage	V _{GS} =0V , I _D =250uA	60	---	---	V
R _{DS(ON)}	Static Drain-Source On-Resistance ²	V _{GS} =10V , I _D =4A	---	---	50	mΩ
		V _{GS} =4.5V , I _D =2A	---	---	60	
V _{GS(th)}	Gate Threshold Voltage	V _{GS} =V _{DS} , I _D =250uA	1.0	---	2.5	V
I _{DSS}	Drain-Source Leakage Current	V _{DS} =48V , V _{GS} =0V , T _J =25°C	---	---	1	uA
		V _{DS} =48V , V _{GS} =0V , T _J =55°C	---	---	5	
I _{GSS}	Gate-Source Leakage Current	V _{GS} =±20V , V _{DS} =0V	---	---	±100	nA
g _{fs}	Forward Transconductance	V _{DS} =5V , I _D =4A	---	28.3	---	S
Q _g	Total Gate Charge (10V)	V _{DS} =48V , V _{GS} =10V , I _D =4A	---	19	---	nC
Q _{gs}	Gate-Source Charge		---	2.6	---	
Q _{gd}	Gate-Drain Charge		---	4.1	---	
T _{d(on)}	Turn-On Delay Time	V _{DD} =30V , V _{GS} =10V , R _G =3.3Ω I _D =4A	---	3	---	ns
T _r	Rise Time		---	34	---	
T _{d(off)}	Turn-Off Delay Time		---	23	---	
T _f	Fall Time		---	6	---	
C _{iss}	Input Capacitance	V _{DS} =15V , V _{GS} =0V , f=1MHz	---	1027	---	pF
C _{oss}	Output Capacitance		---	65	---	
C _{rss}	Reverse Transfer Capacitance		---	46	---	

Diode Characteristics

Symbol	Parameter	Conditions	Min.	Typ.	Max.	Unit
I _S	Continuous Source Current ^{1,5}	V _G =V _D =0V , Force Current	---	---	5	A
V _{SD}	Diode Forward Voltage ²	V _{GS} =0V , I _S =1A , T _J =25°C	---	---	1.2	V
t _{rr}	Reverse Recovery Time	I _F =4A , di/dt=100A/μs ,	---	12.1	---	nS
Q _{rr}	Reverse Recovery Charge	T _J =25°C	---	6.7	---	nC

Note :

- 1.The data tested by surface mounted on a 1 inch² FR-4 board with 20Z copper.
- 2.The data tested by pulsed , pulse width ≤ 300us , duty cycle ≤ 2%
- 3.The EAS data shows Max. rating . The test condition is V_{DD}=25V,V_{GS}=10V,L=0.1mH,I_{AS}=21A
- 4.The power dissipation is limited by 150°C junction temperature
- 5.The data is theoretically the same as I_D and I_{DM} , in real applications , should be limited by total power dissipation.

Typical Characteristics

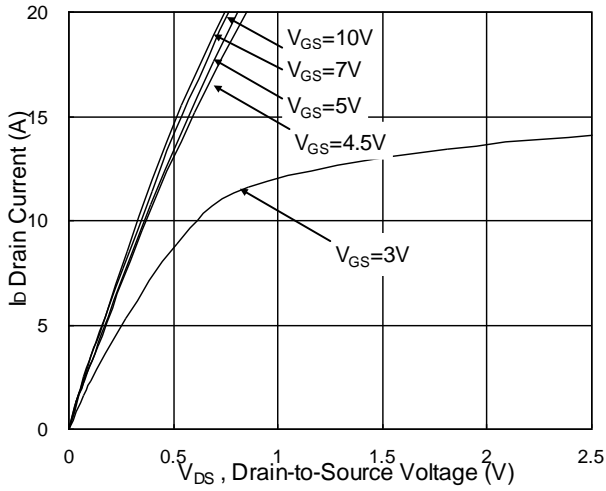

Fig.1 Typical Output Characteristics

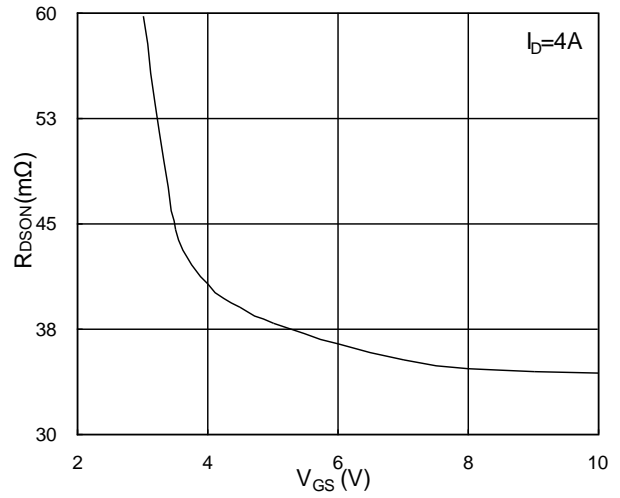

Fig.2 On-Resistance vs. G-S Voltage

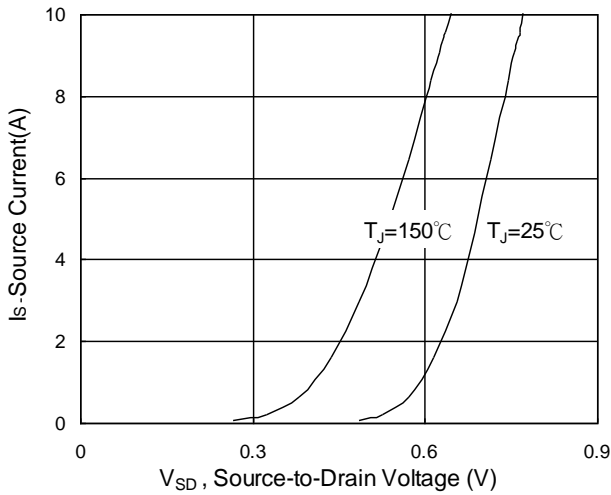

Fig.3 Source Drain Forward Characteristics

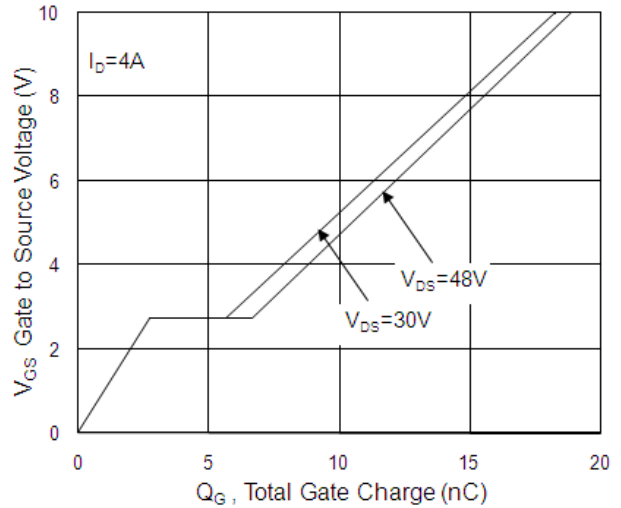

Fig.4 Gate-Charge Characteristics

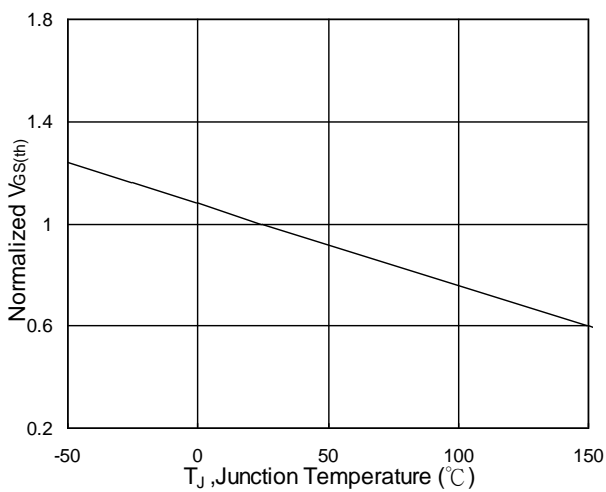

Fig.5 Normalized VGS(th) vs. TJ

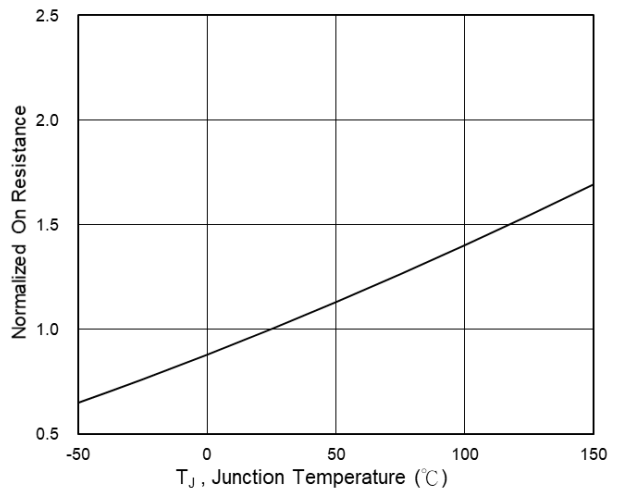

Fig.6 Normalized RDS(on) vs. TJ

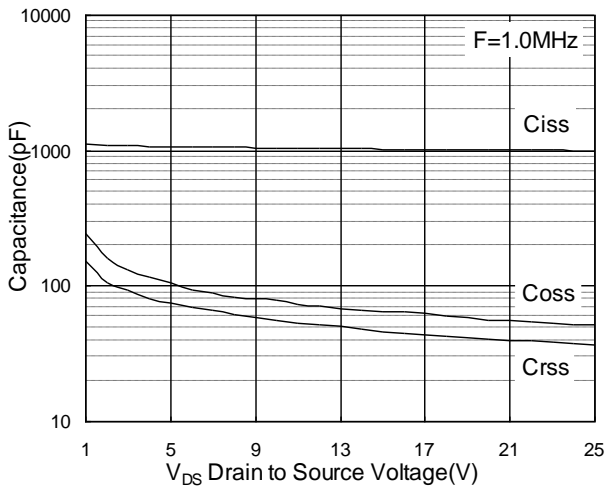

Fig.7 Capacitance

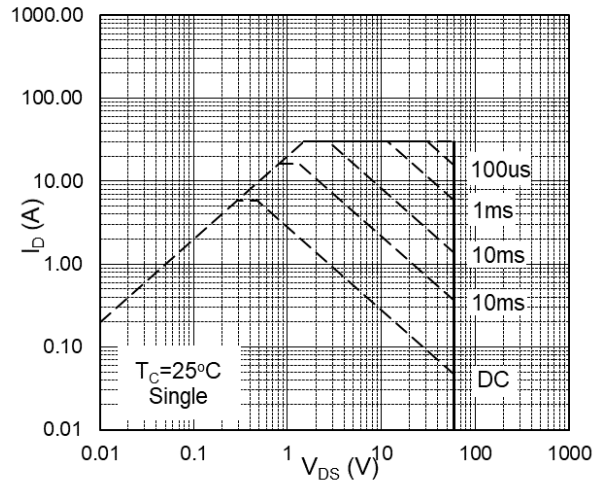

Fig.8 Safe Operating Area

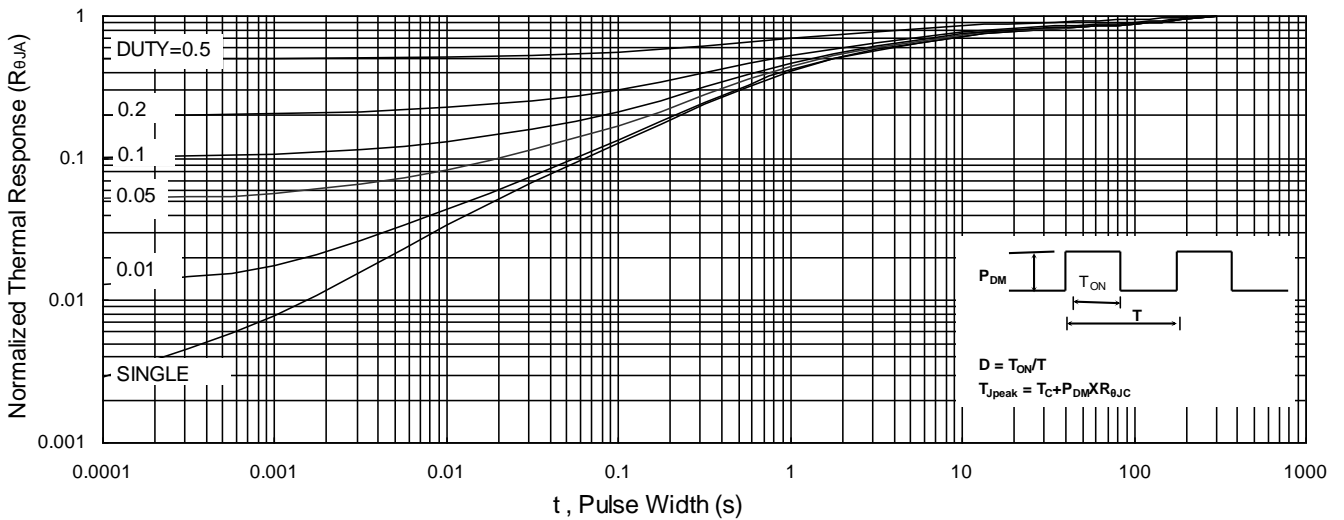

Fig.9 Normalized Maximum Transient Thermal Impedance

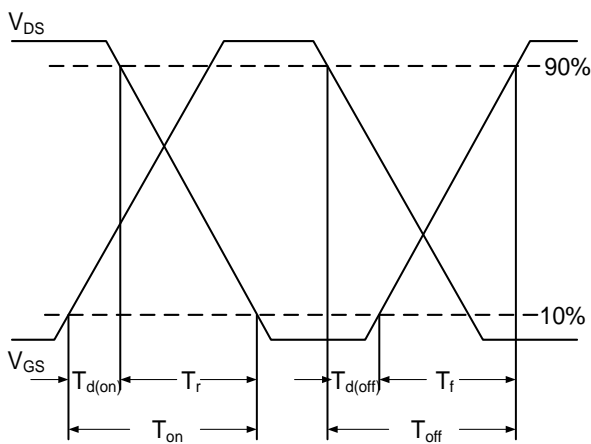

Fig.10 Switching Time Waveform

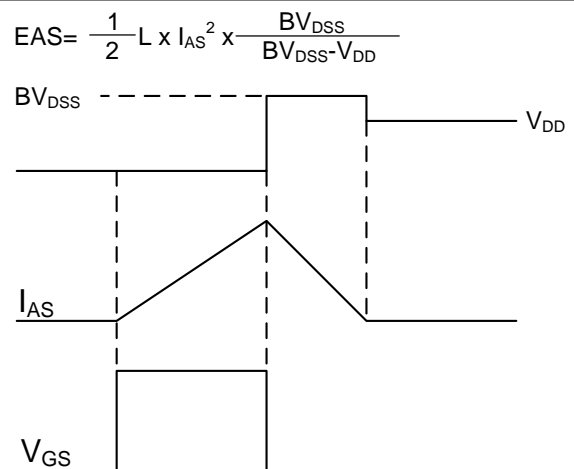

Fig.11 Unclamped Inductive Switching Waveform