

Features

- Advanced Trench MOS Technology
- 100% EAS Guaranteed
- Reliable and Rugged
- Green Device Available

Applications

- Power Management.
- DC Motor Control.

Product Summary

BVDSS	RDSON	ID
-100V	210mΩ	-8.7A

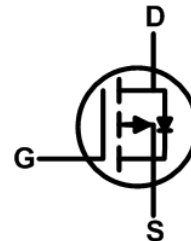
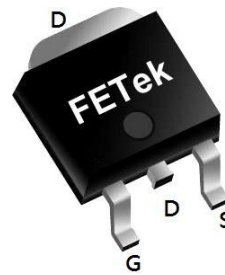
TO252 Pin Configuration

Absolute Maximum Ratings

Symbol	Parameter	Rating	Units
V_{DS}	Drain-Source Voltage	-100	V
V_{GS}	Gate-Source Voltage	± 20	V
$I_D@T_C=25^\circ C$	Continuous Drain Current, $V_{GS} @ -10V^1$	-8.7	A
$I_D@T_C=100^\circ C$	Continuous Drain Current, $V_{GS} @ -10V^1$	-5.5	A
$I_D@T_A=25^\circ C$	Continuous Drain Current, $V_{GS} @ -10V^1$	-2.1	A
$I_D@T_A=70^\circ C$	Continuous Drain Current, $V_{GS} @ -10V^1$	-1.7	A
I_{DM}	Pulsed Drain Current ²	-17.4	A
EAS	Single Pulse Avalanche Energy ³	49	mJ
I_{AS}	Avalanche Current	-14	A
$P_D@T_C=25^\circ C$	Total Power Dissipation ⁴	34.7	W
$P_D@T_A=25^\circ C$	Total Power Dissipation ⁴	2	W
T_{STG}	Storage Temperature Range	-55 to 150	$^\circ C$
T_J	Operating Junction Temperature Range	-55 to 150	$^\circ C$

Thermal Data

Symbol	Parameter	Typ.	Max.	Unit
$R_{\theta JA}$	Thermal Resistance Junction-Ambient ¹	---	62	$^\circ C/W$
$R_{\theta JC}$	Thermal Resistance Junction-Case ¹	---	3.6	$^\circ C/W$

Electrical Characteristics ($T_J=25\text{ }^\circ\text{C}$, unless otherwise noted)

Symbol	Parameter	Conditions	Min.	Typ.	Max.	Unit
BV_{DSS}	Drain-Source Breakdown Voltage	$V_{GS}=0V, I_D=-250\mu A$	-100	---	---	V
$R_{DS(ON)}$	Static Drain-Source On-Resistance ²	$V_{GS}=-10V, I_D=-5A$	---	---	210	m Ω
		$V_{GS}=-4.5V, I_D=-5A$	---	---	240	
$V_{GS(th)}$	Gate Threshold Voltage	$V_{GS}=V_{DS}, I_D=-250\mu A$	-1.2	---	-2.5	V
I_{DSS}	Drain-Source Leakage Current	$V_{DS}=-80V, V_{GS}=0V, T_J=25^\circ C$	---	---	-1	uA
		$V_{DS}=-80V, V_{GS}=0V, T_J=85^\circ C$	---	---	-30	
I_{GSS}	Gate-Source Leakage Current	$V_{GS}=\pm 20V, V_{DS}=0V$	---	---	± 100	nA
R_g	Gate Resistance	$V_{DS}=0V, V_{GS}=0V, f=1MHz$	---	13	---	Ω
Q_g	Total Gate Charge	$V_{DS}=-50V, V_{GS}=-10V, I_D=-5A$	---	19	---	nC
Q_{gs}	Gate-Source Charge		---	3.4	---	
Q_{gd}	Gate-Drain Charge		---	2.9	---	
$T_{d(on)}$	Turn-On Delay Time	$V_{DD}=-30V, V_{GS}=-10V, R_G=3.3\Omega, I_D=-1A$	---	9	---	ns
T_r	Rise Time		---	6	---	
$T_{d(off)}$	Turn-Off Delay Time		---	39	---	
T_f	Fall Time		---	33	---	
C_{iss}	Input Capacitance	$V_{DS}=-30V, V_{GS}=0V, f=1MHz$	---	1228	---	pF
C_{oss}	Output Capacitance		---	41	---	
C_{rss}	Reverse Transfer Capacitance		---	29	---	

Diode Characteristics

Symbol	Parameter	Conditions	Min.	Typ.	Max.	Unit
I_S	Continuous Source Current ^{1,5}	$V_G=V_D=0V$, Force Current	---	---	-8.7	A
V_{SD}	Diode Forward Voltage ²	$V_{GS}=0V, I_S=-1A, T_J=25^\circ C$	---	---	-1.2	V

Note :

- 1.The data tested by surface mounted on a 1 inch² FR-4 board with 2OZ copper.
- 2.The data tested by pulsed , pulse width $\leq 300\mu s$, duty cycle $\leq 2\%$
- 3.The EAS data shows Max. rating . The test condition is $V_{DD}=-25V, V_{GS}=-10V, L=0.5mH, I_{AS}=-14A$
- 4.The power dissipation is limited by 150 $^\circ\text{C}$ junction temperature
- 5.The data is theoretically the same as I_D and I_{DM} , in real applications , should be limited by total power dissipation.

Typical Characteristics

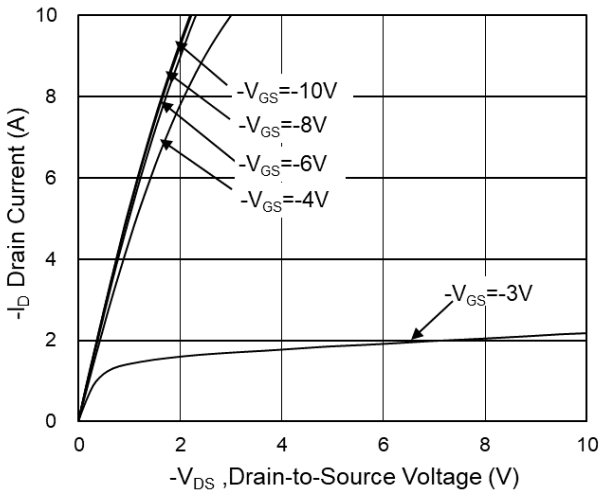

Fig.1 Typical Output Characteristics

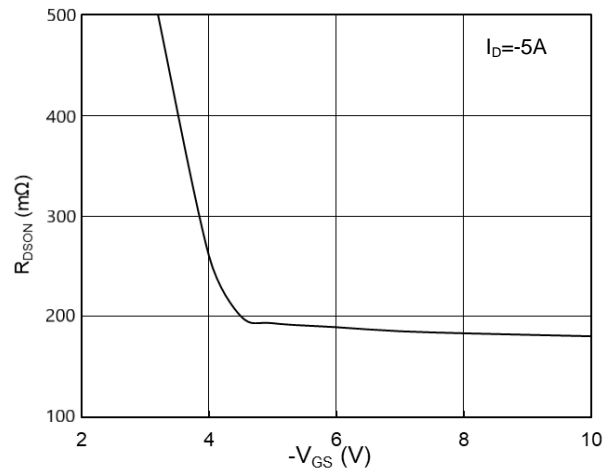

Fig.2 On-Resistance vs G-S Voltage

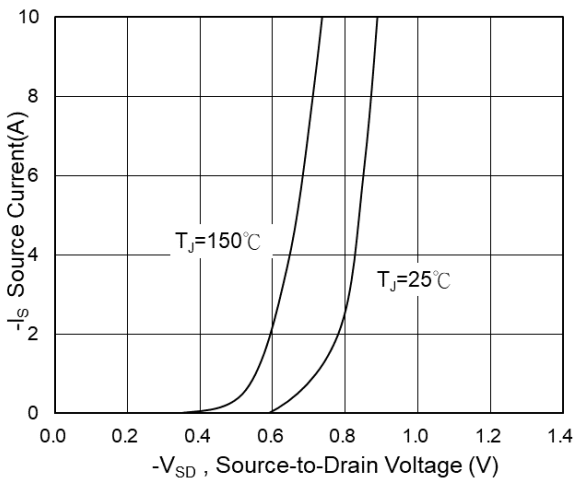

Fig.3 Source Drain Forward Characteristics

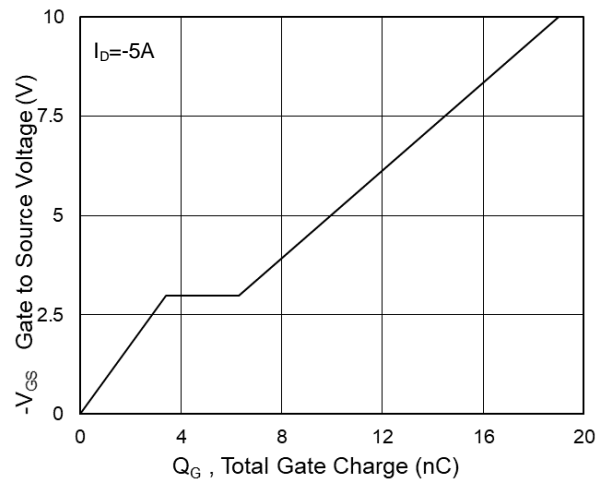

Fig.4 Gate-Charge Characteristics

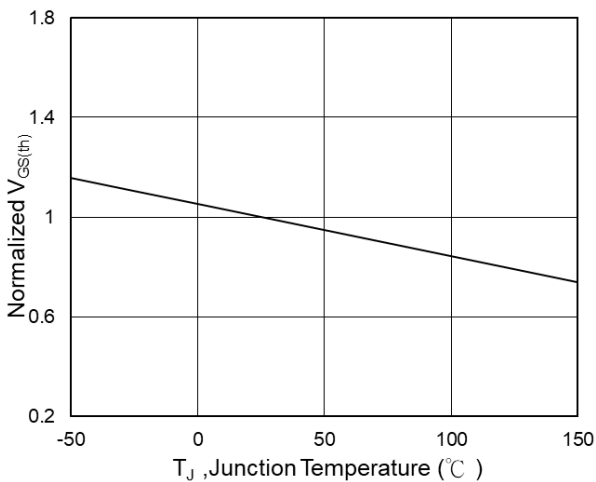

Fig.5 Normalized $V_{GS(th)}$ vs T_J

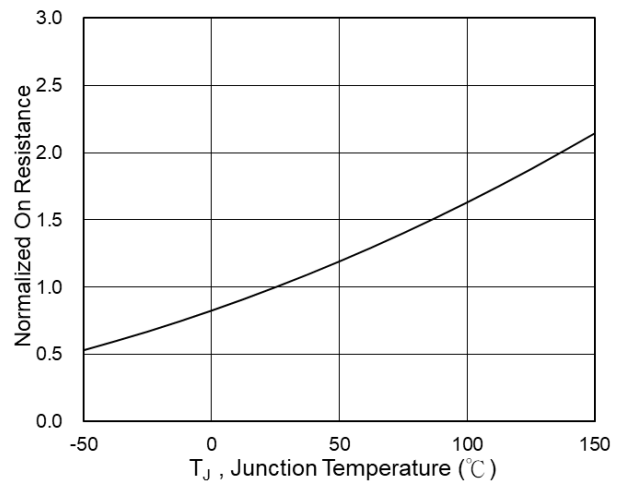

Fig.6 Normalized $R_{DS(on)}$ vs T_J

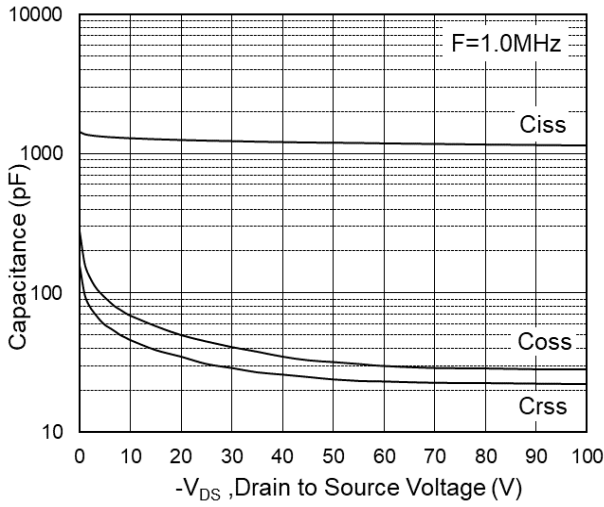

Fig.7 Capacitance

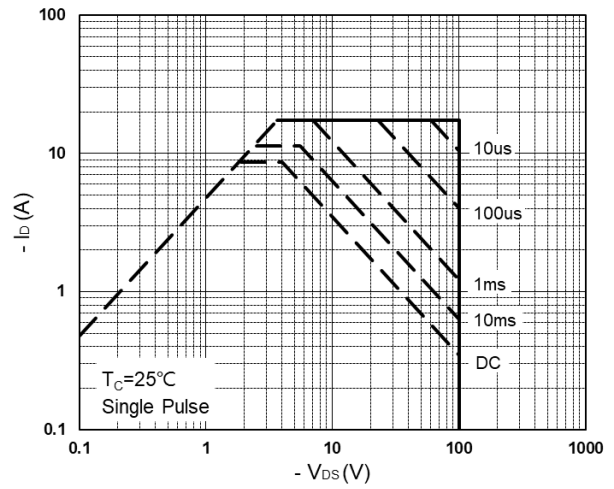

Fig.8 Safe Operating Area

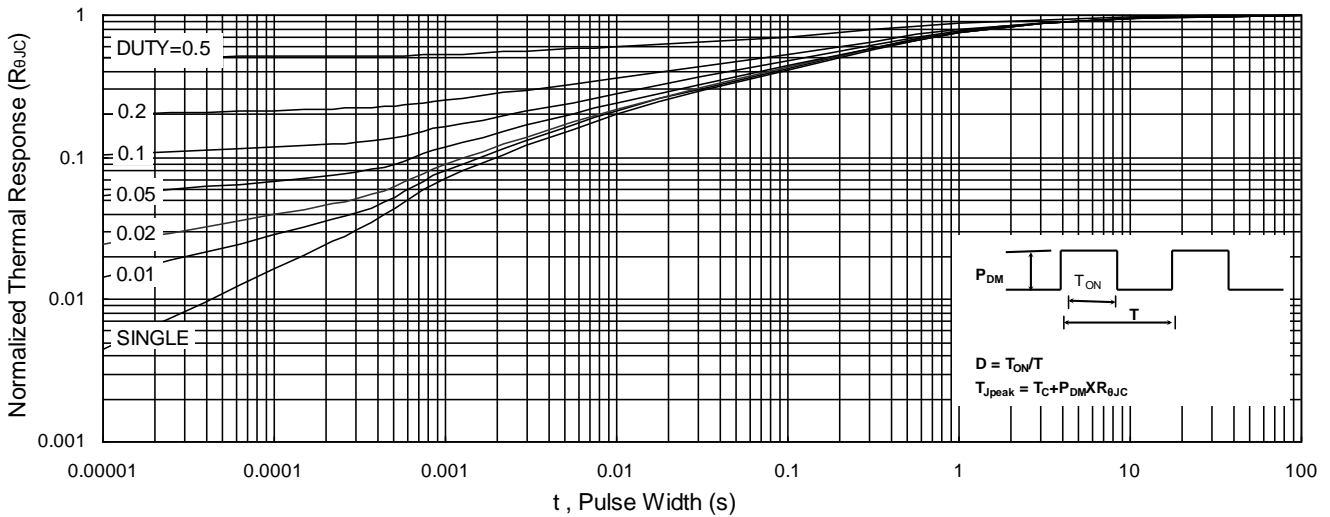

Fig.9 Normalized Maximum Transient Thermal Impedance

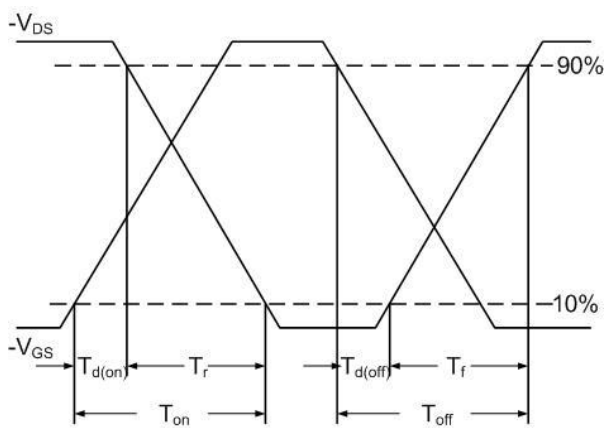

Fig.10 Switching Time Waveform

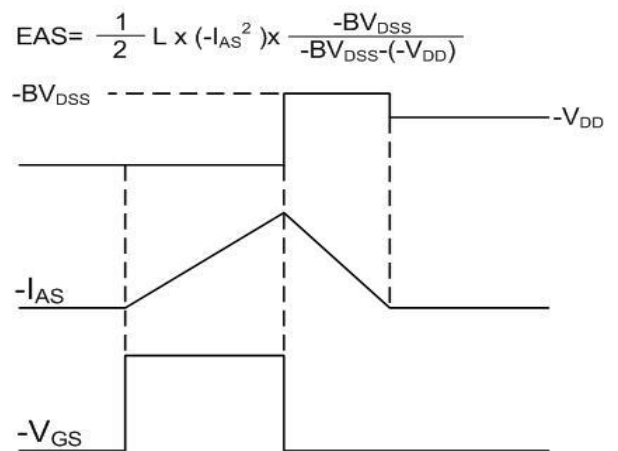

Fig.11 Unclamped Inductive Waveform