

**Features**

- Advanced Trench MOS Technology
- 100% EAS Guaranteed
- Fast Switching Speed
- Green Device Available

**Applications**

- High Frequency Switching and Synchronous Rectification.
- DC/DC Converter.

**Product Summary**

BVDSS	RDSON	ID
100V	8.5mΩ	73A

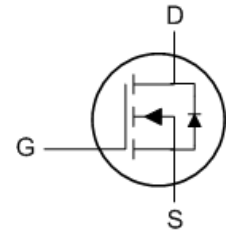
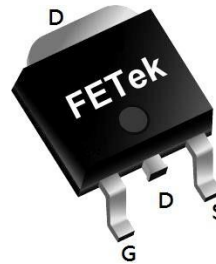
**TO252 Pin Configuration**

**Absolute Maximum Ratings**

Symbol	Parameter	Rating	Units
$V_{DS}$	Drain-Source Voltage	100	V
$V_{GS}$	Gate-Source Voltage	$\pm 20$	V
$I_D @ T_C=25^\circ C$	Continuous Drain Current <sup>1</sup>	73	A
$I_D @ T_C=70^\circ C$	Continuous Drain Current <sup>1</sup>	46	A
$I_{DM}$	Pulsed Drain Current <sup>2</sup>	290	A
EAS	Single Pulse Avalanche Energy <sup>3</sup>	61	mJ
$I_{AS}$	Avalanche Current	35	A
$P_D @ T_C=25^\circ C$	Total Power Dissipation <sup>4</sup>	108	W
$T_{STG}$	Storage Temperature Range	-55 to 150	$^\circ C$
$T_J$	Operating Junction Temperature Range	-55 to 150	$^\circ C$

**Thermal Data**

Symbol	Parameter	Typ.	Max.	Unit
$R_{\theta JA}$	Thermal Resistance Junction-Ambient <sup>1</sup> ( $t \leq 10s$ )	---	25	$^\circ C/W$
	Thermal Resistance Junction-Ambient <sup>1</sup>	---	55	$^\circ C/W$
$R_{\theta JC}$	Thermal Resistance Junction-Case <sup>1</sup>	---	1.15	$^\circ C/W$

**Electrical Characteristics ( $T_J=25^\circ\text{C}$ , unless otherwise noted)**

Symbol	Parameter	Conditions	Min.	Typ.	Max.	Unit
$BV_{DSS}$	Drain-Source Breakdown Voltage	$V_{GS}=0V, I_D=250\mu A$	100	---	---	V
$R_{DS(ON)}$	Static Drain-Source On-Resistance <sup>2</sup>	$V_{GS}=10V, I_D=13.5A$	---	6.6	8.5	m $\Omega$
	Static Drain-Source On-Resistance <sup>2</sup>	$V_{GS}=4.5V, I_D=11.5A$	---	8.7	11	
$V_{GS(th)}$	Gate Threshold Voltage	$V_{GS}=V_{DS}, I_D=250\mu A$	1.2	---	2.3	V
$I_{DSS}$	Drain-Source Leakage Current	$V_{DS}=80V, V_{GS}=0V, T_J=25^\circ\text{C}$	---	---	1	$\mu A$
		$V_{DS}=80V, V_{GS}=0V, T_J=55^\circ\text{C}$	---	---	5	
$I_{GSS}$	Gate-Source Leakage Current	$V_{GS}=\pm 20V, V_{DS}=0V$	---	---	$\pm 100$	nA
$g_{fs}$	Forward Transconductance	$V_{DS}=5V, I_D=20A$	---	85	---	S
$Q_g$	Total Gate Charge (10V)	$V_{DS}=50V, V_{GS}=10V, I_D=13.5A$	---	45	---	nC
$Q_g$	Total Gate Charge (4.5V)		---	19.3	---	
$Q_{gs}$	Gate-Source Charge		---	9.5	---	
$Q_{gd}$	Gate-Drain Charge		---	4.8	---	
$T_d(on)$	Turn-On Delay Time	$V_{DD}=50V, V_{GS}=10V, R_G=3\Omega, I_D=13.5A$	---	10	---	ns
$T_r$	Rise Time		---	6.5	---	
$T_d(off)$	Turn-Off Delay Time		---	45	---	
$T_f$	Fall Time		---	7.5	---	
$C_{iss}$	Input Capacitance	$V_{DS}=50V, V_{GS}=0V, f=1\text{MHz}$	---	3320	---	$\mu F$
$C_{oss}$	Output Capacitance		---	605	---	
$C_{rss}$	Reverse Transfer Capacitance		---	20	---	

**Diode Characteristics**

Symbol	Parameter	Conditions	Min.	Typ.	Max.	Unit
$I_S$	Continuous Source Current <sup>1,5</sup>	$V_G=V_D=0V$ , Force Current	---	---	48	A
$V_{SD}$	Diode Forward Voltage <sup>2</sup>	$V_{GS}=0V, I_S=1A, T_J=25^\circ\text{C}$	---	---	1.1	V
$t_{rr}$	Reverse Recovery Time	$I_F=13.5A, di/dt=100A/\mu s, T_J=25^\circ\text{C}$	---	33	---	nS
$Q_{rr}$	Reverse Recovery Charge		---	150	---	nC

Note :

- 1.The data tested by surface mounted on a 1 inch<sup>2</sup> FR-4 board with 2OZ copper.
- 2.The data tested by pulsed , pulse width  $\leq 300\mu s$ , duty cycle  $\leq 2\%$
- 3.The EAS data shows Max. rating . The test condition is  $V_{DD}=50V, V_{GS}=10V, L=0.3mH, I_{AS}=35A$
- 4.The power dissipation is limited by  $150^\circ\text{C}$  junction temperature
- 5.The data is theoretically the same as  $I_D$  and  $I_{DM}$ , in real applications , should be limited by total power dissipation.

Typical Characteristics

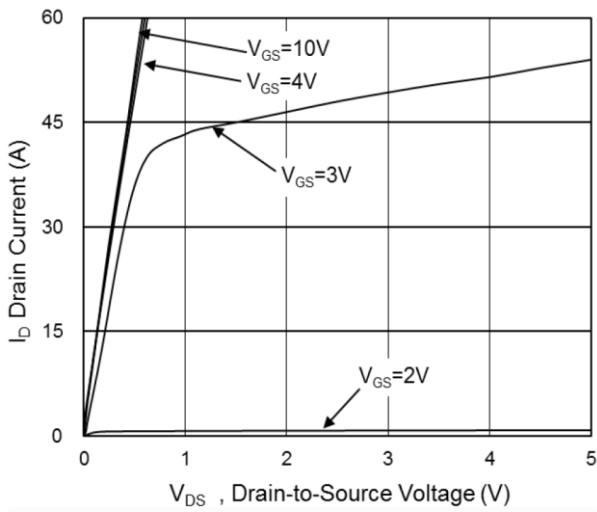

Fig.1 Typical Output Characteristics

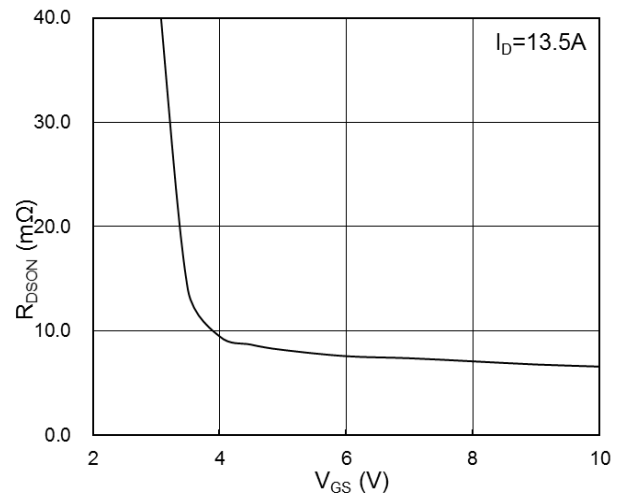

Fig.2 On-Resistance vs G-S Voltage

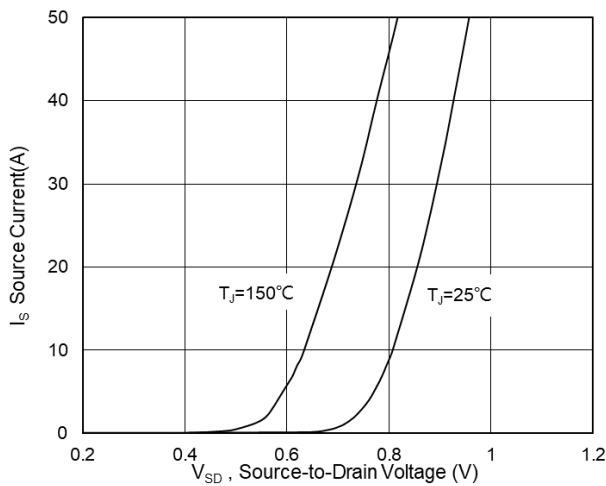

Fig.3 Source Drain Forward Characteristics

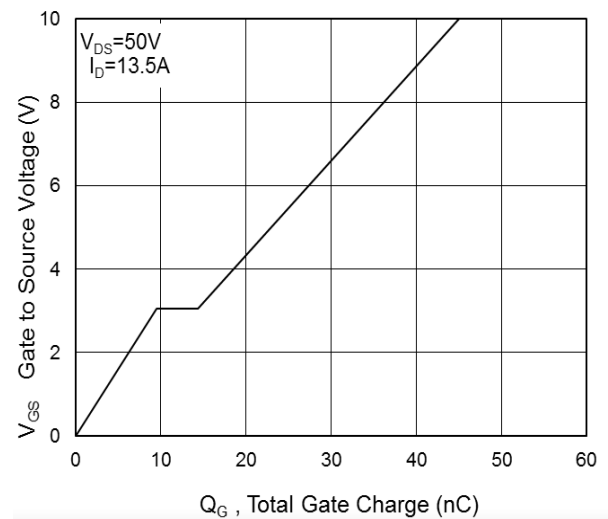

Fig.4 Gate-Charge Characteristics

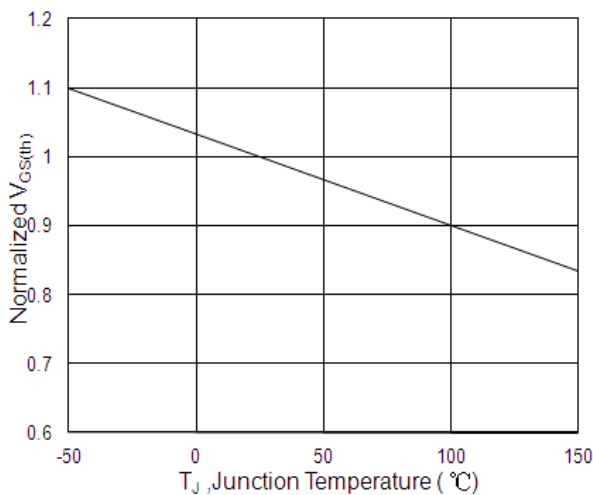

Fig.5 Normalized  $V_{GS(th)}$  vs  $T_J$

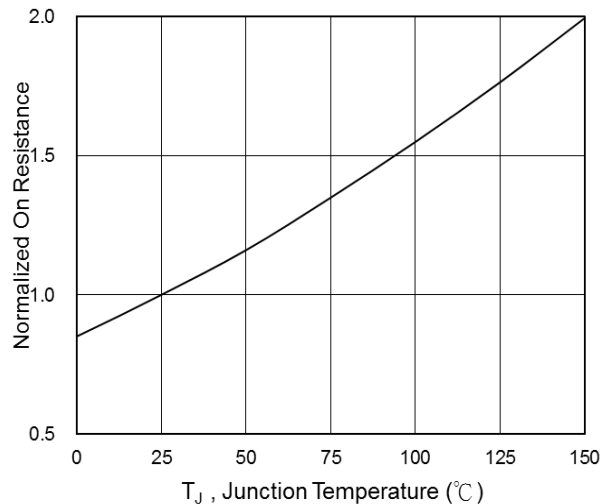

Fig.6 Normalized  $R_{DS(on)}$  vs  $T_J$

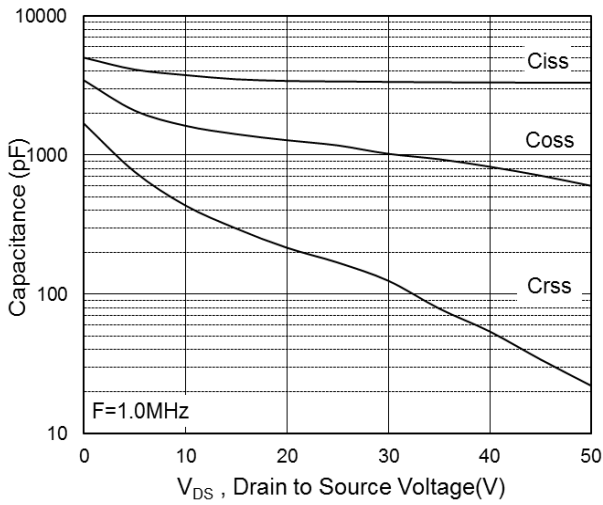

Fig.7 Capacitance

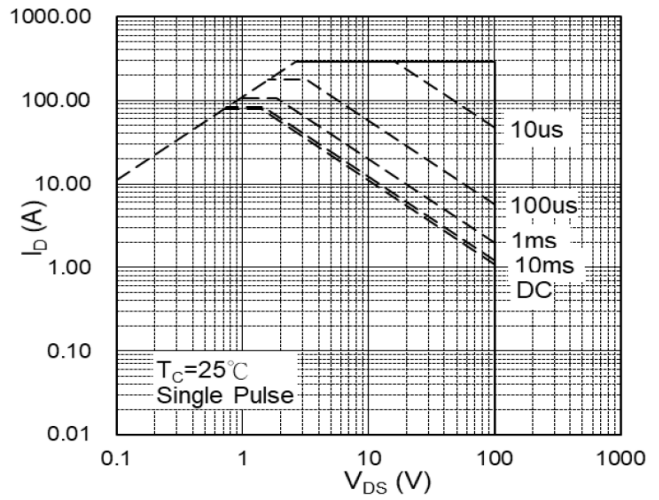

Fig.8 Safe Operating Area

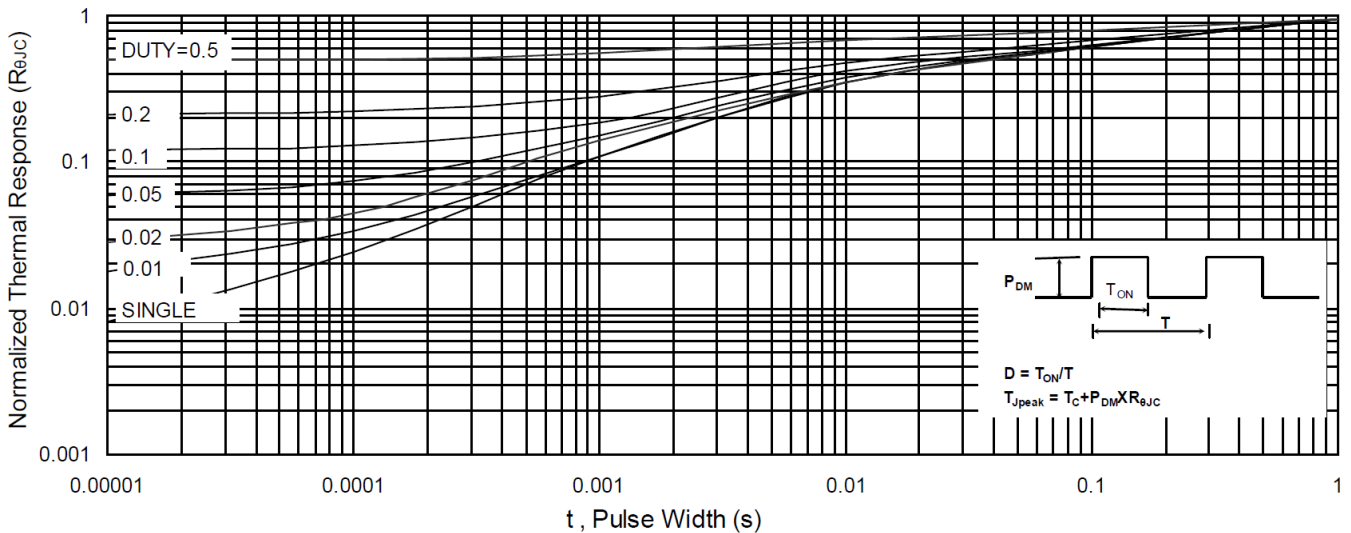

Fig.9 Normalized Maximum Transient Thermal Impedance

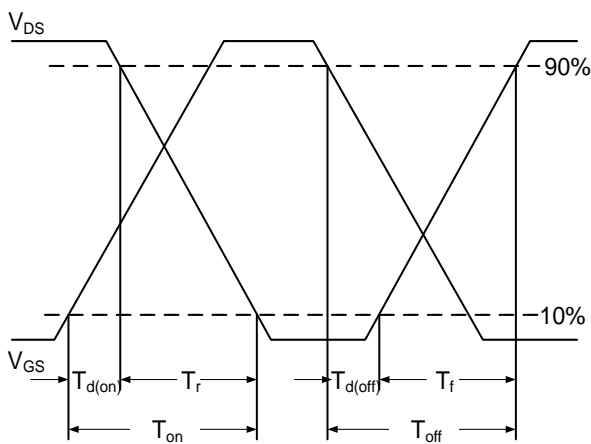

Fig.10 Switching Time Waveform

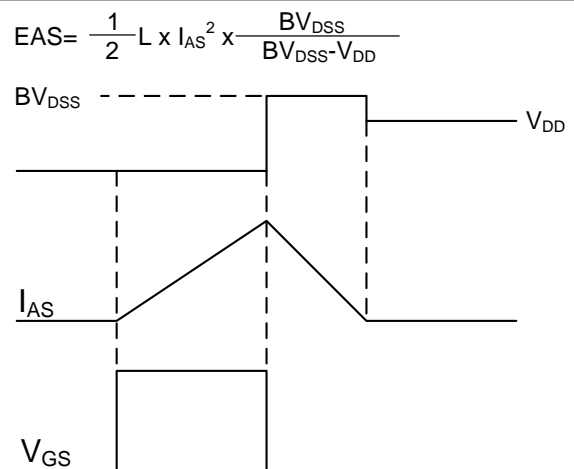

Fig.11 Unclamped Inductive Waveform