

**Features**

- Advanced Trench MOS Technology
- Low Gate Charge
- 100% EAS Guaranteed
- Green Device Available

**Product Summary**

BVDSS	RDSON	ID
30V	5mΩ	30A

**Application**

- Power Management in Desktop Computer.
- DC/DC Converters.

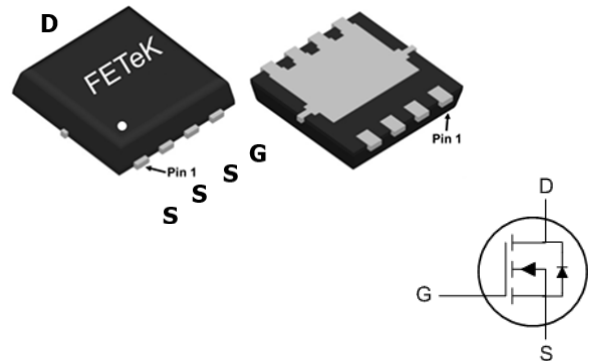
**PRPAK3x3 Pin Configuration**

**Absolute Maximum Ratings**

Symbol	Parameter	Rating	Units
$V_{DS}$	Drain-Source Voltage	30	V
$V_{GS}$	Gate-Source Voltage	$\pm 20$	V
$I_D @ T_C=25^\circ C$	Continuous Drain Current, $V_{GS} @ 10V^{1,6}$	30	A
$I_D @ T_C=100^\circ C$	Continuous Drain Current, $V_{GS} @ 10V^{1,6}$	19	A
$I_{DM}$	Pulsed Drain Current <sup>2</sup>	100	A
EAS	Single Pulse Avalanche Energy <sup>3</sup>	48	mJ
$I_{AS}$	Avalanche Current	31	A
$P_D @ T_C=25^\circ C$	Total Power Dissipation <sup>4</sup>	24	W
$T_{STG}$	Storage Temperature Range	-55 to 150	$^\circ C$
$T_J$	Operating Junction Temperature Range	-55 to 150	$^\circ C$

**Thermal Data**

Symbol	Parameter	Typ.	Max.	Unit
$R_{\theta JA}$	Thermal Resistance Junction-ambient <sup>1</sup>	---	60	$^\circ C/W$
$R_{\theta JC}$	Thermal Resistance Junction-case <sup>1</sup>	---	5.2	$^\circ C/W$

Electrical Characteristics ( $T_J=25\text{ }^\circ\text{C}$ , unless otherwise noted)

Symbol	Parameter	Conditions	Min.	Typ.	Max.	Unit
$BV_{DSS}$	Drain-Source Breakdown Voltage	$V_{GS}=0V, I_D=250\mu A$	30	---	---	V
$R_{DS(ON)}$	Static Drain-Source On-Resistance <sup>2</sup>	$V_{GS}=10V, I_D=15A$	---	4	5	m $\Omega$
		$V_{GS}=4.5V, I_D=15A$	---	6.3	7.5	m $\Omega$
$V_{GS(th)}$	Gate Threshold Voltage	$V_{GS}=V_{DS}, I_D=250\mu A$	1.2	1.7	2.5	V
$I_{DSS}$	Drain-Source Leakage Current	$V_{DS}=24V, V_{GS}=0V, T_J=25^\circ C$	---	---	1	$\mu A$
		$V_{DS}=24V, V_{GS}=0V, T_J=55^\circ C$	---	---	5	
$I_{GSS}$	Gate-Source Leakage Current	$V_{GS}=\pm 20V, V_{DS}=0V$	---	---	$\pm 100$	nA
$R_g$	Gate Resistance	$V_{DS}=0V, V_{GS}=0V, f=1MHz$	---	1.8	---	$\Omega$
$Q_g$	Total Gate Charge (10V)	$V_{DS}=15V, V_{GS}=10V, I_D=15A$	---	16.5	---	nC
$Q_g$	Total Gate Charge (4.5V)		---	8.5	---	
$Q_{gs}$	Gate-Source Charge		---	2.9	---	
$Q_{gd}$	Gate-Drain Charge		---	3.5	---	
$T_{d(on)}$	Turn-On Delay Time	$V_{DD}=15V, V_{GS}=10V, R_G=3.3\Omega, I_D=15A$	---	7	---	ns
$T_r$	Rise Time		---	42	---	
$T_{d(off)}$	Turn-Off Delay Time		---	16	---	
$T_f$	Fall Time		---	6.2	---	
$C_{iss}$	Input Capacitance	$V_{DS}=15V, V_{GS}=0V, f=1MHz$	---	882	---	pF
$C_{oss}$	Output Capacitance		---	380	---	
$C_{rss}$	Reverse Transfer Capacitance		---	65	---	

## Diode Characteristics

Symbol	Parameter	Conditions	Min.	Typ.	Max.	Unit
$I_S$	Continuous Source Current <sup>1,5,6</sup>	$V_G=V_D=0V$ , Force Current	---	---	30	A
$V_{SD}$	Diode Forward Voltage <sup>2</sup>	$V_{GS}=0V, I_S=1A, T_J=25^\circ C$	---	---	1.2	V

Note :

- The data tested by surface mounted on a 1 inch<sup>2</sup> FR-4 board with 2OZ copper.
- Single pulse width limited by junction temperature  $T_{J(MAX)}=150^\circ C$ .
- The EAS data shows Max. rating . The test condition is  $V_{DD}=25V, V_{GS}=10V, L=0.1mH, I_{AS}=31A$
- The power dissipation is limited by  $150^\circ C$  junction temperature
- The data is theoretically the same as  $I_D$  and  $I_{DM}$ , in real applications, should be limited by total power dissipation.
- The maximum current rating is package limited.

Typical Characteristics

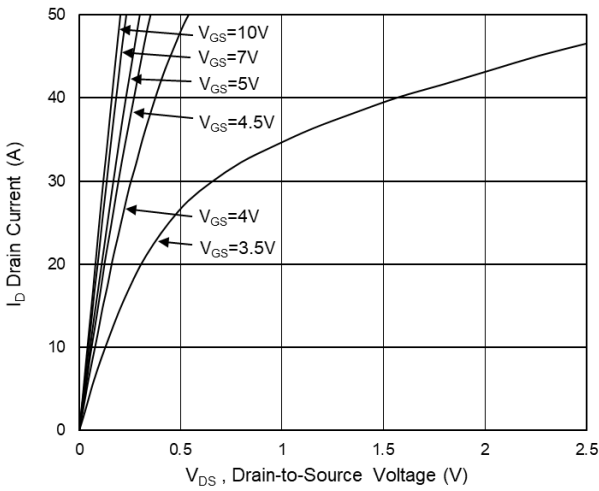

Fig.1 Typical Output Characteristics

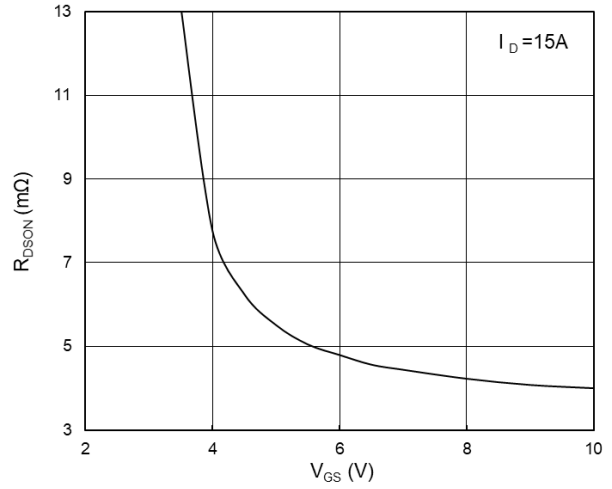

Fig.2 On-Resistance vs G-S Voltage

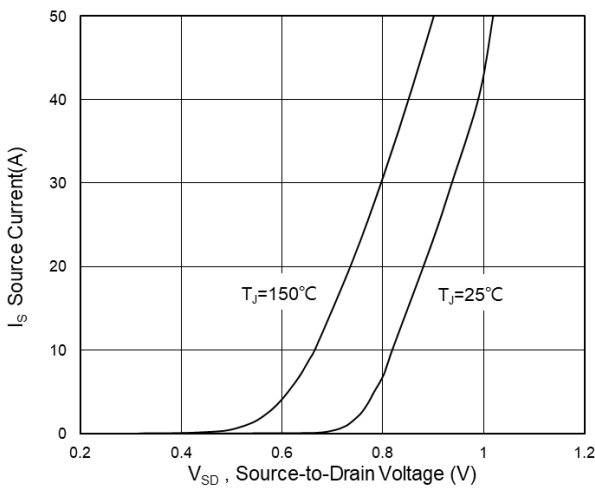

Fig.3 Source Drain Forward Characteristics

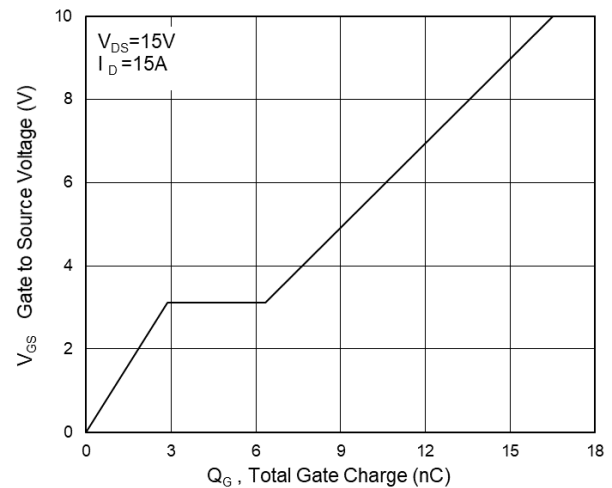

Fig.4 Gate-Charge Characteristics

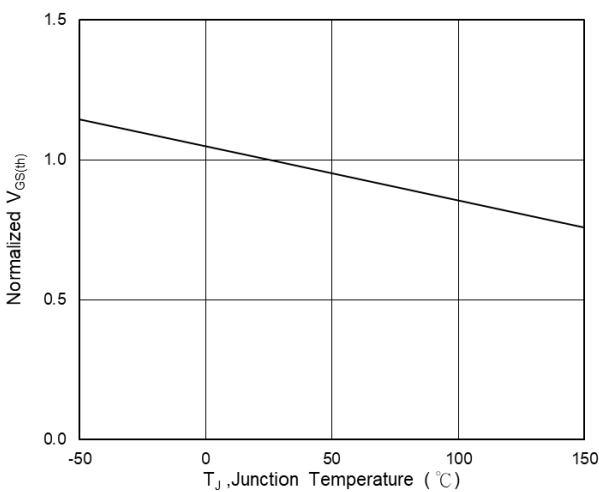

Fig.5 Normalized  $V_{GS(th)}$  vs  $T_J$

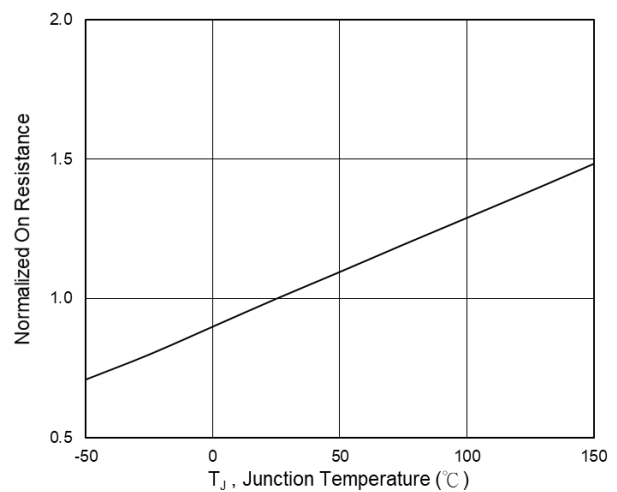

Fig.6 Normalized  $R_{DS(on)}$  vs  $T_J$

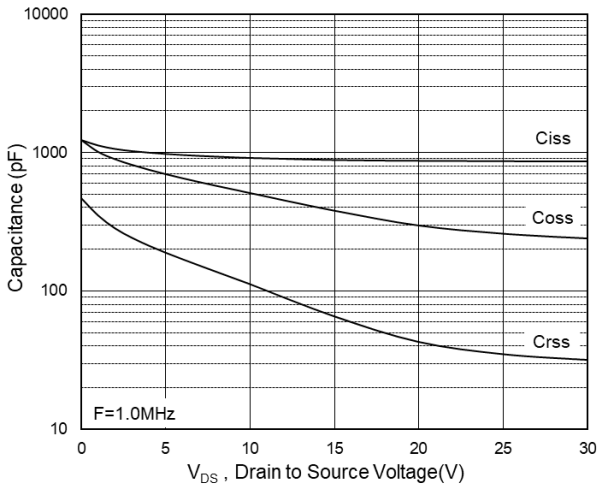

Fig.7 Capacitance

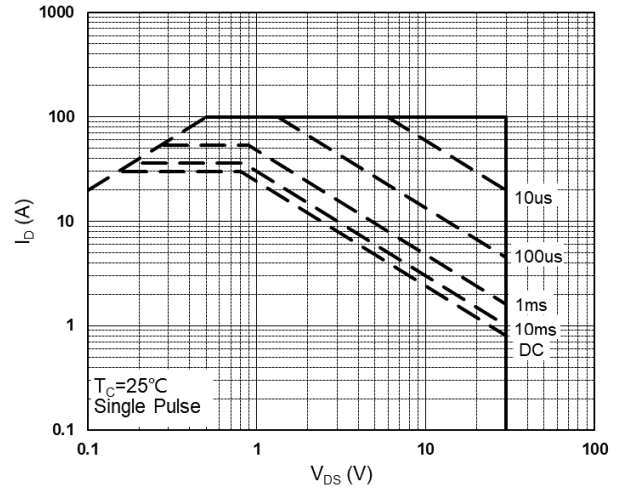

Fig.8 Safe Operating Area

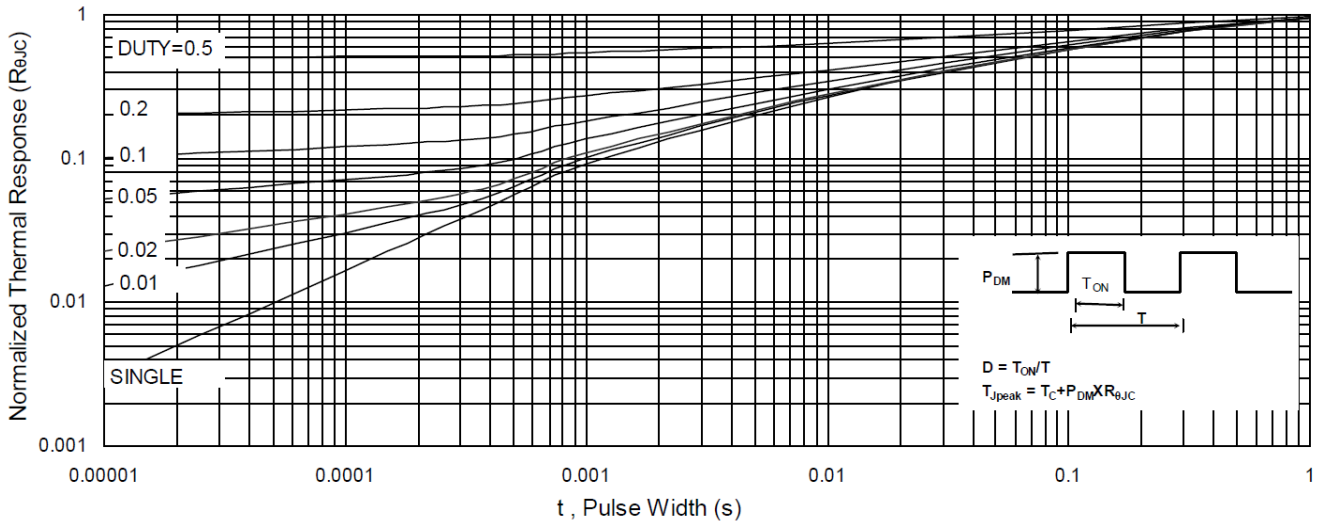

Fig.9 Normalized Maximum Transient Thermal Impedance



Fig.10 Switching Time Waveform



Fig.11 Unclamped Inductive Waveform