

**Features**

- Advanced Trench MOS Technology
- Low Gate Charge
- Low  $R_{DS(ON)}$
- 100% EAS Guaranteed
- Green Device Available

**Applications**

- Power Management in Desktop Computer or DC/DC Converters.
- Isolated DC/DC Converters in Telecom and Industrial.

**Product Summary**

BVDSS	RDSON	ID
30V	3.9mΩ	35A

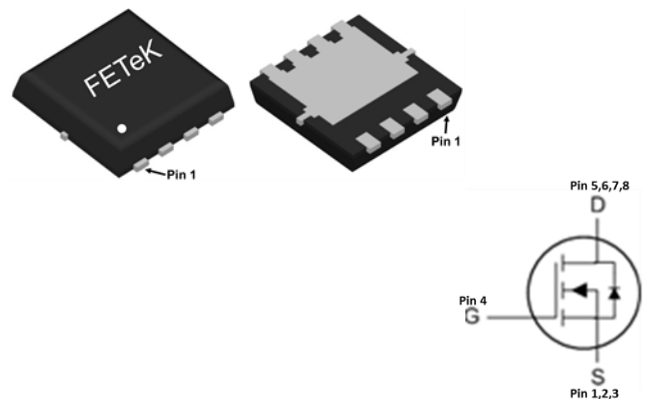
**PRPAK3X3 Pin Configuration**

**Absolute Maximum Ratings**

Symbol	Parameter	Rating	Units
$V_{DS}$	Drain-Source Voltage	30	V
$V_{GS}$	Gate-Source Voltage	$\pm 20$	V
$I_D@T_C=25^\circ C$	Continuous Drain Current, $V_{GS}$ @ 10V <sup>1</sup>	35	A
$I_D@T_C=100^\circ C$	Continuous Drain Current, $V_{GS}$ @ 10V <sup>1</sup>	32	A
$I_{DM}$	Pulsed Drain Current <sup>2</sup>	120	A
EAS	Single Pulse Avalanche Energy <sup>3</sup>	80	mJ
$I_{AS}$	Avalanche Current	40	A
$P_D@T_C=25^\circ C$	Total Power Dissipation <sup>4</sup>	27	W
$T_{STG}$	Storage Temperature Range	-55 to 150	°C
$T_J$	Operating Junction Temperature Range	-55 to 150	°C

**Thermal Data**

Symbol	Parameter	Typ.	Max.	Unit
$R_{\theta JA}$	Thermal Resistance Junction-Ambient <sup>1</sup>	---	60	°C/W
$R_{\theta JC}$	Thermal Resistance Junction-Case <sup>1</sup>	---	4.5	°C/W

N-Channel Electrical Characteristics ( $T_J=25^\circ\text{C}$ , unless otherwise noted)

Symbol	Parameter	Conditions	Min.	Typ.	Max.	Unit
$BV_{DSS}$	Drain-Source Breakdown Voltage	$V_{GS}=0V, I_D=250\mu A$	30	---	---	V
$R_{DS(ON)}$	Static Drain-Source On-Resistance <sup>2</sup>	$V_{GS}=10V, I_D=20A$	---	3.2	3.9	m $\Omega$
		$V_{GS}=4.5V, I_D=15A$	---	4.9	6.1	
$V_{GS(th)}$	Gate Threshold Voltage	$V_{GS}=V_{DS}, I_D=250\mu A$	1.2	1.7	2.2	V
$I_{DSS}$	Drain-Source Leakage Current	$V_{DS}=30V, V_{GS}=0V, T_J=25^\circ\text{C}$	---	---	1	$\mu A$
		$V_{DS}=30V, V_{GS}=0V, T_J=55^\circ\text{C}$	---	---	5	
$I_{GSS}$	Gate-Source Leakage Current	$V_{GS}=\pm 20V, V_{DS}=0V$	---	---	$\pm 100$	nA
$g_{fs}$	Forward Transconductance	$V_{DS}=5V, I_D=20A$	---	75	---	S
$R_g$	Gate Resistance	$V_{DS}=0V, V_{GS}=0V, f=1\text{MHz}$	0.7	1.65	2.6	$\Omega$
$Q_g$	Total Gate Charge (4.5V)	$V_{DS}=15V, V_{GS}=4.5V, I_D=20A$	---	14.7	---	nC
$Q_{gs}$	Gate-Source Charge		---	5.8	---	
$Q_{gd}$	Gate-Drain Charge		---	3.5	---	
$T_{d(on)}$	Turn-On Delay Time	$V_{DD}=15V, V_{GS}=10V, R_G=3\Omega, I_D=20A$	---	7.5	---	ns
$T_r$	Rise Time		---	20.2	---	
$T_{d(off)}$	Turn-Off Delay Time		---	21.6	---	
$T_f$	Fall Time		---	4.4	---	
$C_{iss}$	Input Capacitance	$V_{DS}=15V, V_{GS}=0V, f=1\text{MHz}$	---	1476	---	pF
$C_{oss}$	Output Capacitance		---	556	---	
$C_{rss}$	Reverse Transfer Capacitance		---	70	---	

## Diode Characteristics

Symbol	Parameter	Conditions	Min.	Typ.	Max.	Unit
$I_S$	Continuous Source Current <sup>1,5</sup>	$V_G=V_D=0V$ , Force Current	---	---	30	A
$V_{SD}$	Diode Forward Voltage <sup>2</sup>	$V_{GS}=0V, I_S=1A, T_J=25^\circ\text{C}$	---	---	1	V

Note :

- The data tested by surface mounted on a 1 inch<sup>2</sup> FR-4 board with 2OZ copper.
- The data tested by pulsed, pulse width  $\leq 300\mu s$ , duty cycle  $\leq 2\%$
- The EAS data shows Max. rating. The test condition is  $V_{DD}=25V, V_{GS}=10V, L=0.1\text{mH}, I_{AS}=40A$
- The power dissipation is limited by  $150^\circ\text{C}$  junction temperature
- The data is theoretically the same as  $I_D$  and  $I_{DM}$ , in real applications, should be limited by total power dissipation.

**N-Channel Typical Characteristics**

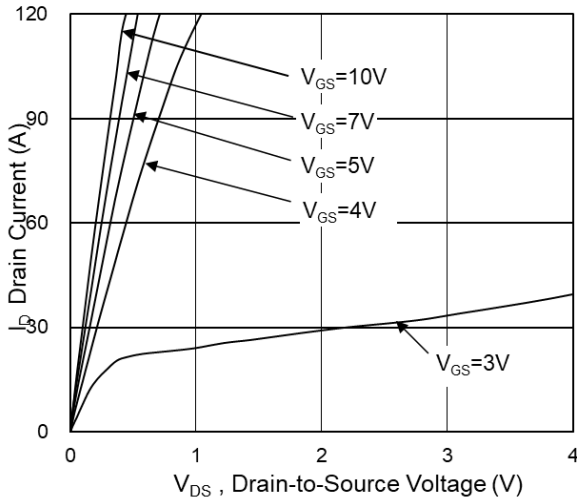

**Fig.1 Typical Output Characteristics**

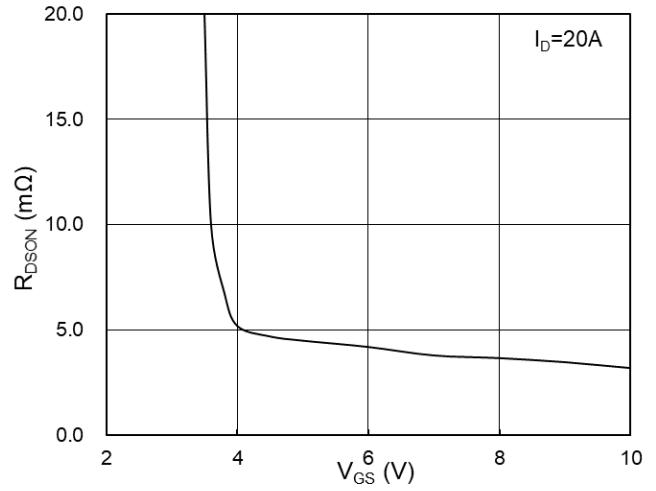

**Fig.2 On-Resistance vs G-S Voltage**

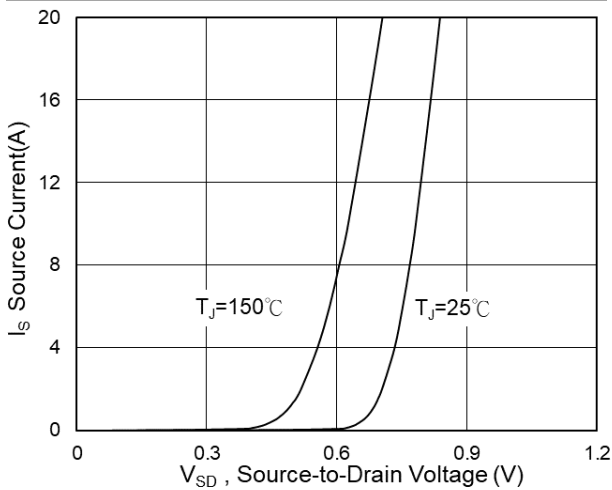

**Fig.3 Source Drain Forward Characteristics**

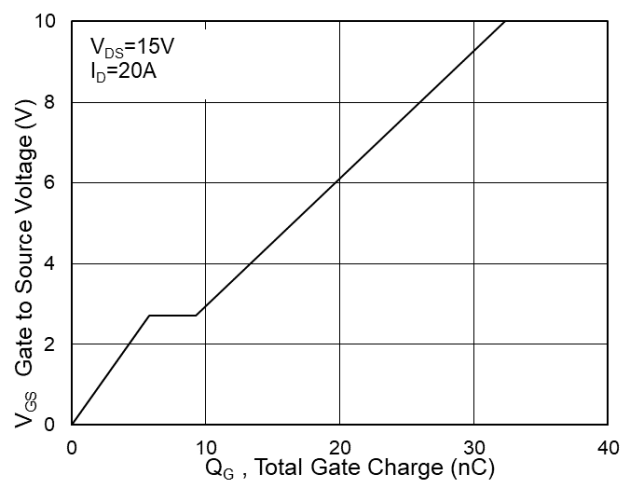

**Fig.4 Gate-Charge Characteristics**

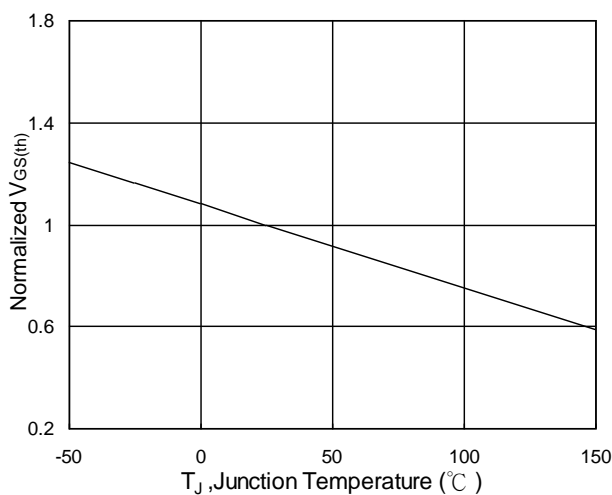

**Fig.5 Normalized  $V_{GS(th)}$  vs  $T_J$**

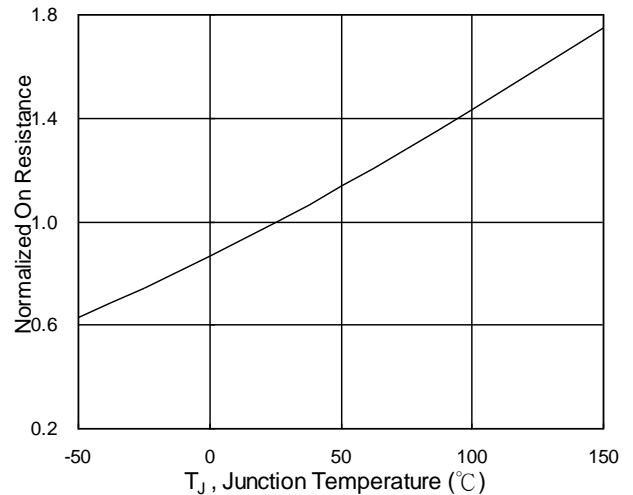

**Fig.6 Normalized  $R_{DS(on)}$  vs  $T_J$**

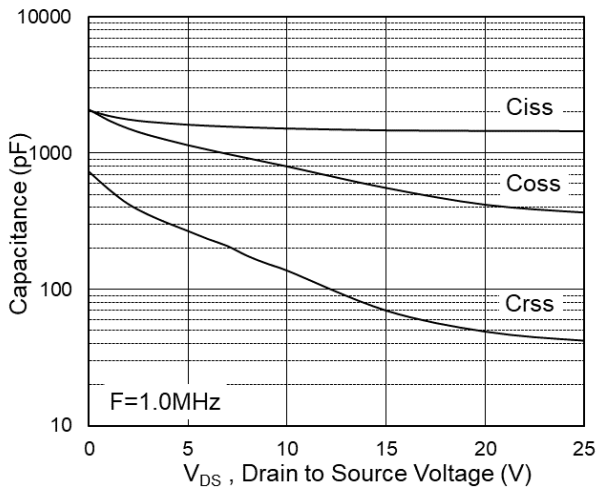

Fig.7 Capacitance

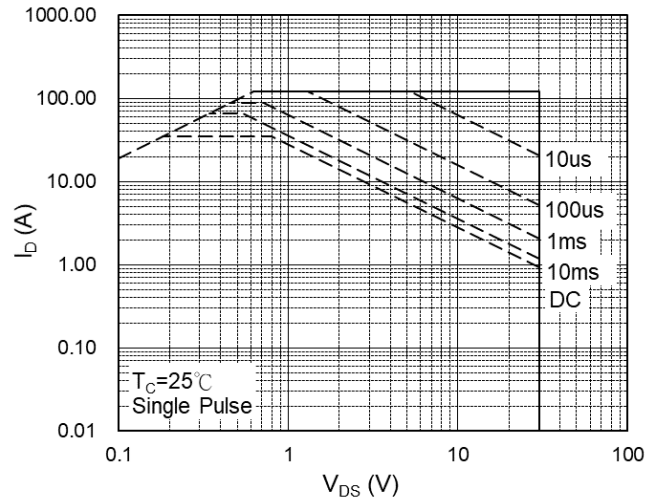

Fig.8 Safe Operating Area

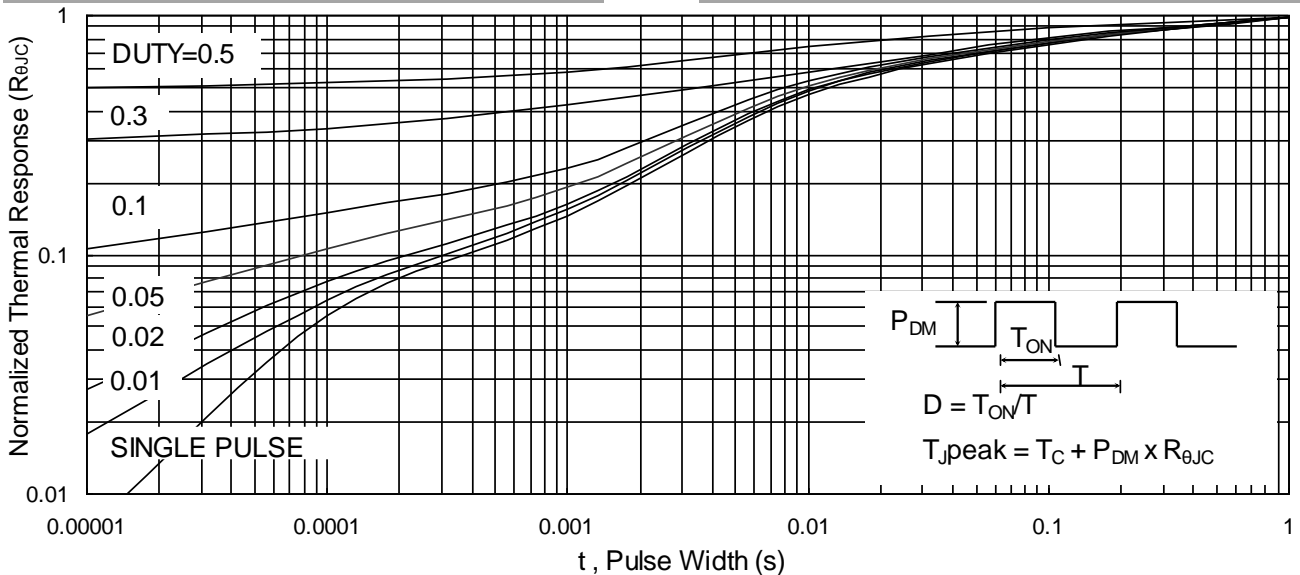

Fig.9 Normalized Maximum Transient Thermal Impedance

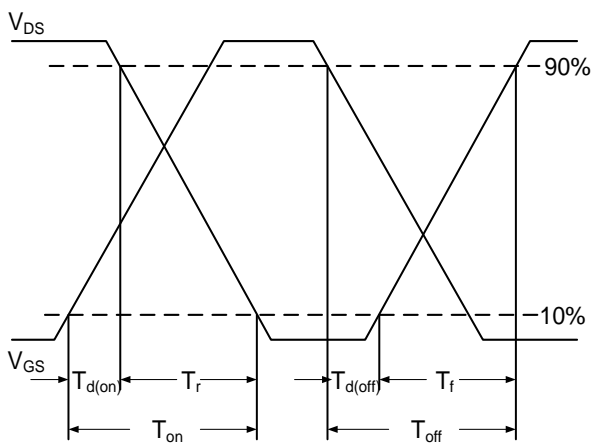

Fig.10 Switching Time Waveform

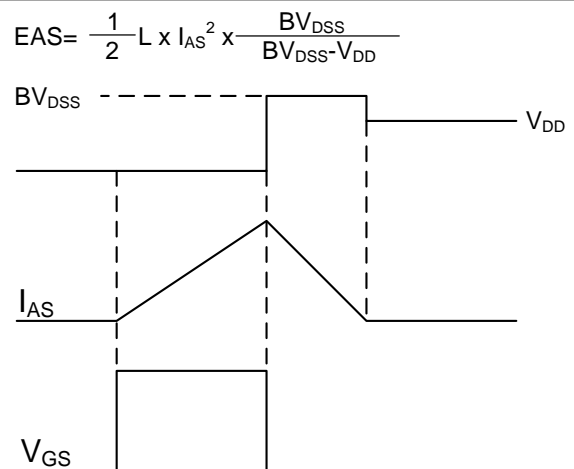

Fig.11 Unclamped Inductive Switching Wave