

**Features**

- ★ Advanced Trench MOS Technology
- ★ 100% EAS Guaranteed
- ★ Fast Switching Speed
- ★ Green Device Available

Applications

- ★ High Frequency Switching and Synchronous Rectification.
- ★ DC/DC Converter.

Product Summary

BVDSS	RDSON	ID
100V	11.5mΩ	60A

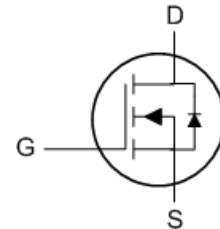
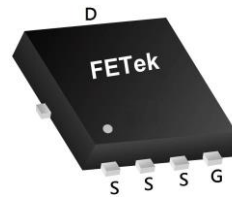
PRPAK5X6 Pin Configuration**Absolute Maximum Ratings**

Symbol	Parameter	Rating	Units
V_{DS}	Drain-Source Voltage	100	V
V_{GS}	Gate-Source Voltage	± 20	V
$I_D@T_C=25^\circ C$	Continuous Drain Current ¹	60	A
$I_D@T_C=100^\circ C$	Continuous Drain Current ¹	39	A
I_{DM}	Pulsed Drain Current ²	160	A
EAS	Single Pulse Avalanche Energy ³	33	mJ
I_{AS}	Avalanche Current	15	A
$P_D@T_C=25^\circ C$	Total Power Dissipation ⁴	56.5	W
T_{STG}	Storage Temperature Range	-55 to 150	$^\circ C$
T_J	Operating Junction Temperature Range	-55 to 150	$^\circ C$

Thermal Data

Symbol	Parameter	Typ.	Max.	Unit
$R_{\theta JA}$	Thermal Resistance Junction-Ambient ¹	---	50	$^\circ C/W$
$R_{\theta JC}$	Thermal Resistance Junction-Case ¹	---	2.2	$^\circ C/W$

Electrical Characteristics (T_J=25 °C, unless otherwise noted)

Symbol	Parameter	Conditions	Min.	Typ.	Max.	Unit
BV _{DSS}	Drain-Source Breakdown Voltage	V _{GS} =0V , I _D =250uA	100	---	---	V
R _{DS(ON)}	Static Drain-Source On-Resistance ²	V _{GS} =10V , I _D =20A	---	8	11.5	mΩ
	Static Drain-Source On-Resistance ²	V _{GS} =4.5V , I _D =10A	---	11.6	15	
V _{GS(th)}	Gate Threshold Voltage	V _{GS} =V _{DS} , I _D =250uA	1.2	---	2.4	V
I _{DSS}	Drain-Source Leakage Current	V _{DS} =80V , V _{GS} =0V , T _J =25°C	---	---	1	uA
		V _{DS} =80V , V _{GS} =0V , T _J =55°C	---	---	5	
I _{GSS}	Gate-Source Leakage Current	V _{GS} =±20V , V _{DS} =0V	---	---	±100	nA
Q _g	Total Gate Charge (10V)	V _{DS} =50V , V _{GS} =10V , I _D =20A	---	29	---	nC
Q _g	Total Gate Charge (4.5V)		---	14	---	
Q _{gs}	Gate-Source Charge		---	6.5	---	
Q _{gd}	Gate-Drain Charge		---	5.5	---	
T _{d(on)}	Turn-On Delay Time	V _{DD} =50V , V _{GS} =10V , R _G =3.3Ω, I _D =20A	---	8	---	ns
T _r	Rise Time		---	4	---	
T _{d(off)}	Turn-Off Delay Time		---	28	---	
T _f	Fall Time		---	6	---	
C _{iss}	Input Capacitance	V _{DS} =50V , V _{GS} =0V , f=1MHz	---	2550	---	pF
C _{oss}	Output Capacitance		---	305	---	
C _{rss}	Reverse Transfer Capacitance		---	12	---	

Diode Characteristics

Symbol	Parameter	Conditions	Min.	Typ.	Max.	Unit
I _S	Continuous Source Current ^{1,5}	V _G =V _D =0V , Force Current	---	---	35	A
V _{SD}	Diode Forward Voltage ²	V _{GS} =0V , I _S =1A , T _J =25°C	---	---	1.2	V
t _{rr}	Reverse Recovery Time	I _F =20A , di/dt=100A/μs ,	---	45	---	nS
Q _{rr}	Reverse Recovery Charge	T _J =25°C	---	165	---	nC

Note :

- 1.The data tested by surface mounted on a 1 inch² FR-4 board with 2OZ copper.
- 2.The data tested by pulsed , pulse width ≤ 300us , duty cycle ≤ 2%
- 3.The EAS data shows Max. rating . The test condition is V_{DD}=25V,V_{GS}=10V,L=0.3mH,I_{AS}=15A
- 4.The power dissipation is limited by 150°C junction temperature
- 5.The data is theoretically the same as I_D and I_{DM} , in real applications , should be limited by total power dissipation.

Typical Characteristics

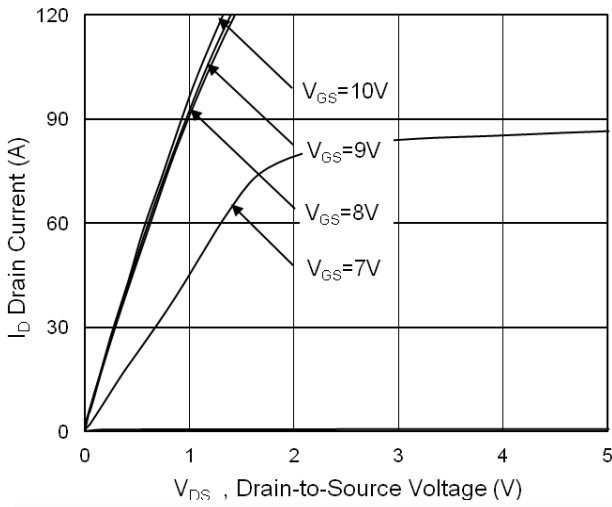

Fig.1 Typical Output Characteristics

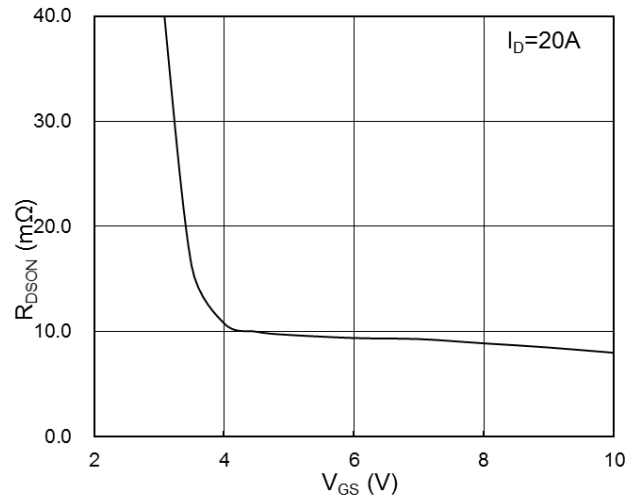

Fig.2 On-Resistance vs G-S Voltage

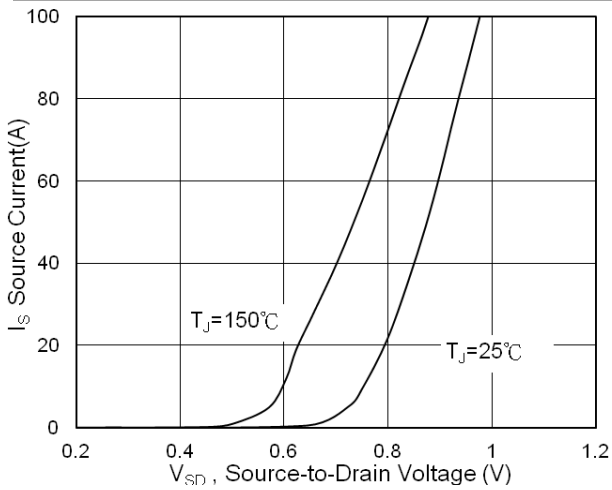

Fig.3 Source Drain Forward Characteristics

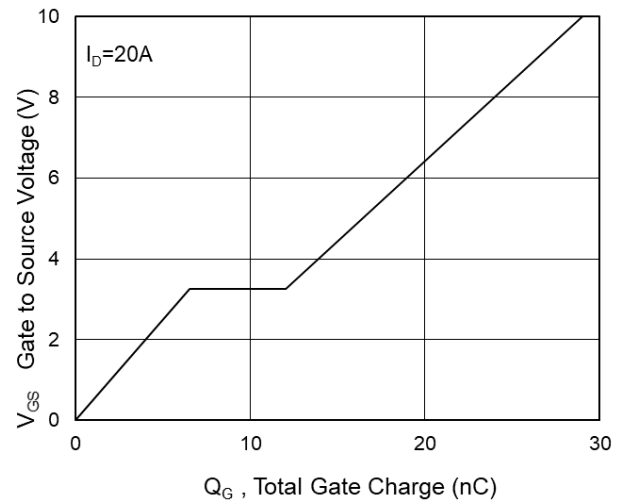

Fig.4 Gate-Charge Characteristics

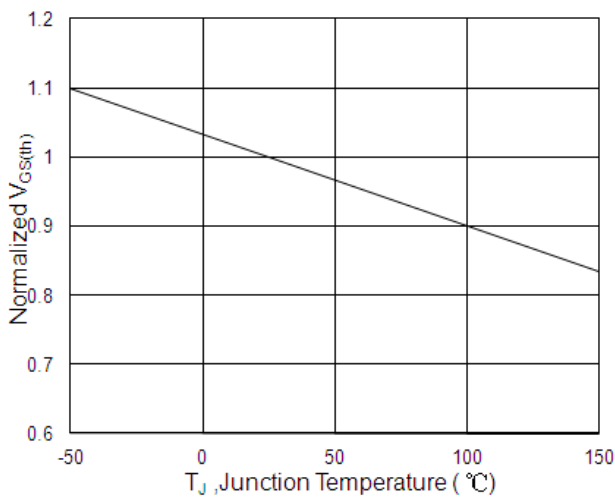

Fig.5 Normalized $V_{GS(th)}$ vs T_J

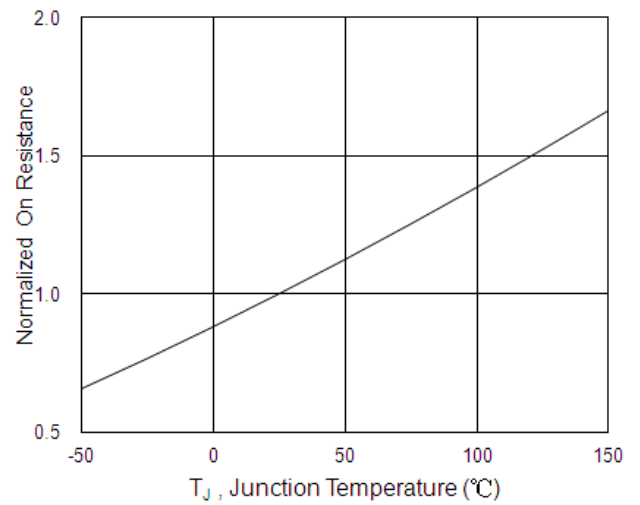

Fig.6 Normalized $R_{DS(on)}$ vs T_J

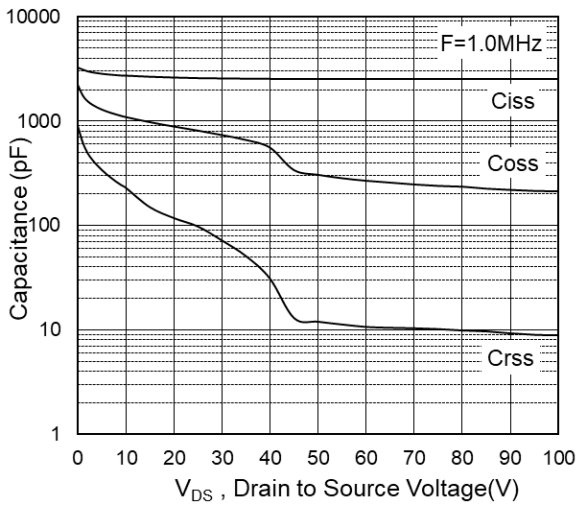

Fig.7 Capacitance

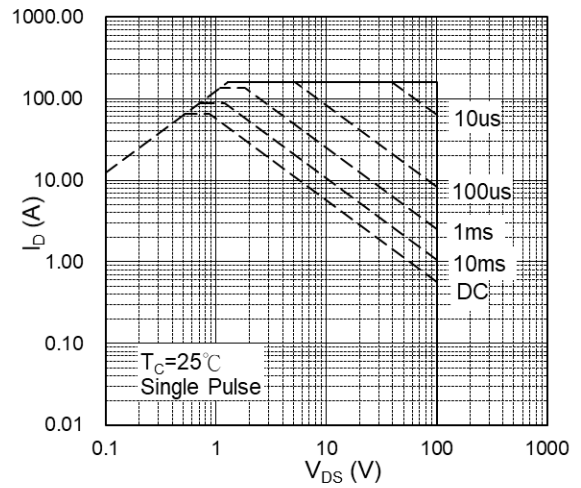

Fig.8 Safe Operating Area

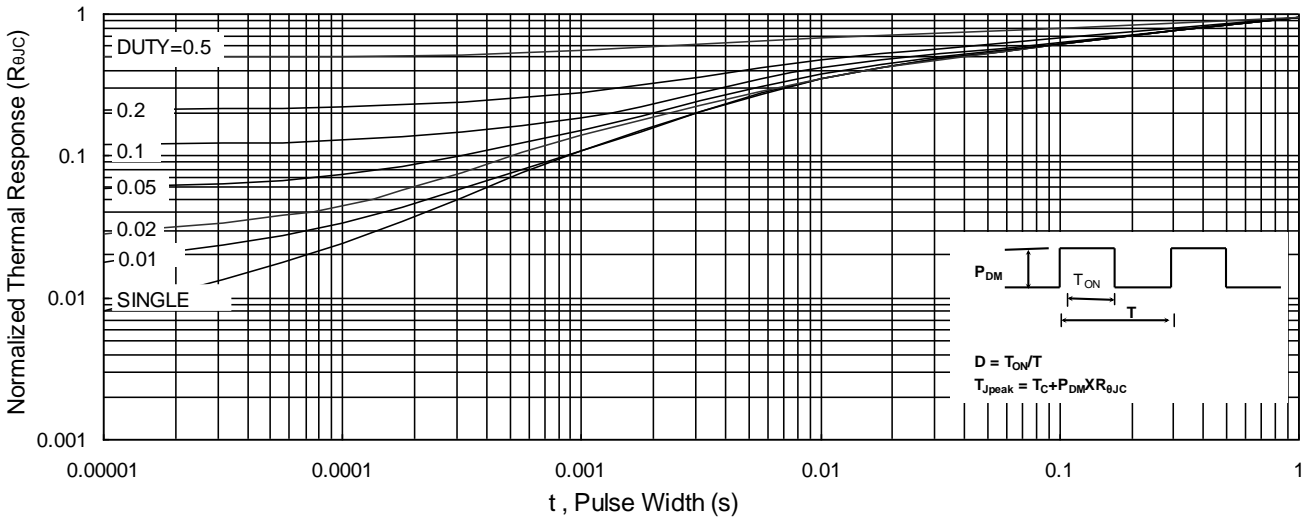

Fig.9 Normalized Maximum Transient Thermal Impedance

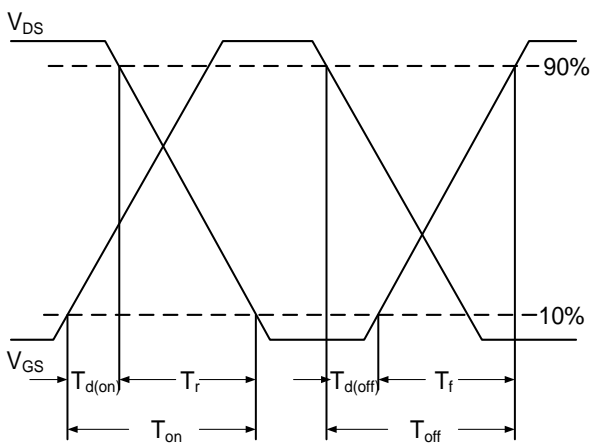

Fig.10 Switching Time Waveform

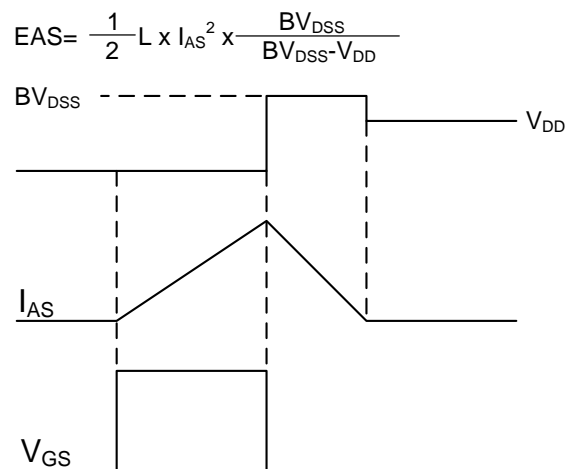

Fig.11 Unclamped Inductive Switching Waveform